

RS 25÷200/M BLU Series

Low NOx Modulating Gas Burners

RS 25/M BLU	45/125	÷	370 kW
RS 35/M BLU	72/202	÷	480 kW
RS 45/M BLU	90/190	÷	550 kW
RS 55/M BLU	100/300	÷	680 kW
RS 68/M BLU	150/350	÷	860 kW
RS 120/M BLU	300/600	÷	1300 kW
RS 160/M BLU	300/930	÷	1860 kW
RS 200/M BLU	570/1375	÷	2400 kW

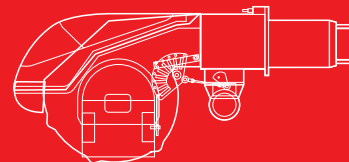
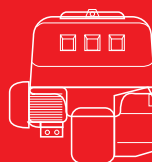

The RS/M BLU burners series covers a firing range from 44 to 2400 kW, and it has been designed for use in low or medium temperature hot water boilers, hot air or steam boilers, diathermic oil boilers. Operation can be "two stage progressive" or, alternatively, "modulating" with the installation of a PID logic regulator and respective probes. RS/M BLU burners series guarantees high efficiency levels in all the various applications, thus reducing fuel consumption and running costs. The exclusive design ensures reduced dimensions, simple use and maintenance. Optimisation of sound emissions is guaranteed by the special design of the air suction circuit and by incorporated sound proofing material.

A wide range of accessories guarantees elevated working flexibility.

Technical Data

MODEL			RS 25/M BLU	RS 35/M BLU	RS 45/M BLU	RS 55/M BLU
Burner operation mode			Modulating (with regulator and probes accessories)			
Modulation ratio at max. output			4 ÷ 1			
Servomotor	type		SQN90			
	run time s		24			
Heat output	kW		45/125÷370	72/202÷480	90/190-550	100/300-680
	Mcal/h		39/107.5 ÷ 318.2	62/173.7 ÷ 413	77.4/163.4 ÷ 473	86/258 ÷ 585
Working temperature	°C min./max.		0/40			
FUEL/AIR DATA						
G20 gas	net calorific value	kWh/Nm ³	10			
	gas density	kg/Nm ³	0.71			
	gas delivery	Nm ³ /h	4.5/12.5÷37	7.2/20.2÷48	9/19 ÷ 55	10/30 ÷ 68
G25 gas	net calorific value	kWh/Nm ³	8.6			
	gas density	kg/Nm ³	0.78			
	gas delivery	Nm ³ /h	5.2/14.5 ÷ 43	8.4/23.5 ÷ 55.8	10.5/22 ÷ 64	11.7/35 ÷ 79
LPG gas	net calorific value	kWh/Nm ³	25.8			
	gas density	kg/Nm ³	2.02			
	gas delivery	Nm ³ /h	1.7/4.9 ÷ 14.4	2.8/7.8 ÷ 18.6	3.5/7.4 ÷ 21.3	3.9/11.7 ÷ 26.4
Fan	type		Forward blade fan		Reverse blade fan	
Air temperature	max °C		60			
ELECTRICAL DATA						
Electrical supply	Ph/Hz/V		1/50/230 ~ (± 10%)		1/50-60/230 ~ (± 10%)	
Auxiliary electrical supply	Ph/Hz/V		1/50/230 ~ (± 10%)		1/50-60/230 ~ (± 10%)	
Control box	type		RMG/M			
Total electrical power	kW		0.6	0.7	0.75	1.5
Auxiliary electrical power	kW		0.3	0.28	0.12	0.12
Heaters electrical power	kW		--			
Protection level	IP		40		44	40
Fan motor	electrical power	kW	0.3	0.42	0.65	1.1
	rated current	A	3.2	3.5	2.9	4.7 - 2.7
	start up current	A	15	17	13.8 - 8	13.8 - 8
	protection level	IP	54			
Ignition transformer	V1 - V2		230V - 1x15 kV	230V - 1x15 kV	230V - 1x8 kV	220/240 - 1x15 kV
	I1 - I2		1A - 25 mA	1A - 25 mA	1A - 20 mA	1A - 25 mA
Operation			Intermittent (at least one stop every 24 h) Continuous as optional (at least one stop every 72 h)			
EMISSIONS						
Noise levels	Sound pressure	dBA	70	72	70	64
	Sound output	W	--			
Gas G20	CO Emission	mg/kWh	< 20			
	NOx Emission	mg/kWh	< 80			
APPROVAL						
Directive			2006/42 - 2009/142 - 2004/108 - 2006/95 EC			
Conforming to			EN 676			
Certification			CE 0085BR0379	CE 0085BR0379	CE 0085BM0104	CE 0085CM0293

MODEL			RS 68/M BLU	RS 120/M BLU	RS 160/M BLU	RS 200/M BLU
Burner operation mode			Modulating (with regulator and probes accessories)			
Modulation ratio at max. output			3 ÷ 1		4 ÷ 1	
Servomotor	type		SQN 31			
	run time s		42			
Heat output	kW		150/350 ÷ 860	300/600 ÷ 1300	300/930 ÷ 1860	570/1375 ÷ 2400
	Mcal/h		129/310 ÷ 739.5	258/516 ÷ 1118	258/800 ÷ 1599	490/1182 ÷ 2064
Working temperature	°C min./max.		0/50			
FUEL/AIR DATA						
G20 gas	net calorific value	kWh/Nm ³	10			
	gas density	kg/Nm ³	0,71			
	gas delivery	Nm ³ /h	15/35 ÷ 86	30/60 ÷ 130	30/93 ÷ 186	57/137.5 ÷ 240
G25 gas	net calorific value	kWh/Nm ³	8,6			
	gas density	kg/Nm ³	0,78			
	gas delivery	Nm ³ /h	17.5/40.7 ÷ 100	34.9/69.8 ÷ 151	34.9/108 ÷ 216.3	66.3/159.9 ÷ 279
LPG gas	net calorific value	kWh/Nm ³	25,8			
	gas density	kg/Nm ³	2,02			
	gas delivery	Nm ³ /h	5.8/13.6 ÷ 33.3	11.6/23.3 ÷ 50.4	11.6/36 ÷ 72	22/53.3 ÷ 93
Fan	type		Reverse curve blades		Forward curve blades	
Air temperature	max °C		60			
ELECTRICAL DATA						
Electrical supply	Ph/Hz/V		3N/50/230-400 ~ (±10%)			
Auxiliary electrical supply	Ph/Hz/V		1/50/230 ~ (±10%)			
Control box	type		RGM/M (intermittent operation) - LGK16 (continuous operation)			
Total electrical power	kW		2.0	2.8	5.3	6.5
Auxiliary electrical power	kW		0.3			
Protection level	IP		44			
Fan motor	electrical power	kW	1.5	2.2	4.5	5.5
	rated current	A	5.9 - 3.4	8.8 - 5.1	15.8 - 9.1	12.3 - 21.3
	start up current	A	32.8 - 19	55.4 - 32	126 - 72.8	83
	protection level	IP	54			
Ignition transformer	V1 - V2		230V - 1 x 5 kV		230V - 1 x 8 kV	
	I1 - I2		1 A - 20 mA			
Operation			Intermittent (at least one stop every 24 h) Continuous (at least one stop every 72 h)			
EMISSIONS						
Noise levels	sound pressure	dB (A)	77	78.5	80.5	83
	sound power	W	---	---	---	---
Gas G20	CO emission	mg/kWh	< 20			
	NOx emission	mg/kWh	< 80			
APPROVAL						
Directive			2006/42 - 2009/142 - 2004/108 - 2006/95 EC			
Conforming to			EN 676			
Certification			CE 0085BM0452	CE 0085BM0452	CE 0085BM0452	CE 0085BT0414

Reference conditions:

Temperature: 20°C - Pressure: 1013,5 mbar - Altitude: 0 m a.s.l. - Noise measured at a distance of 1 meter.

Since the Company is constantly engaged in the production improvement, the aesthetic and dimensional features, the technical data, the equipment and the accessories can be changed. This document contains confidential and proprietary information of RIELLO S.p.A. Unless authorised, this information shall not be divulged, nor duplicated in whole or in part.

Firing Rates

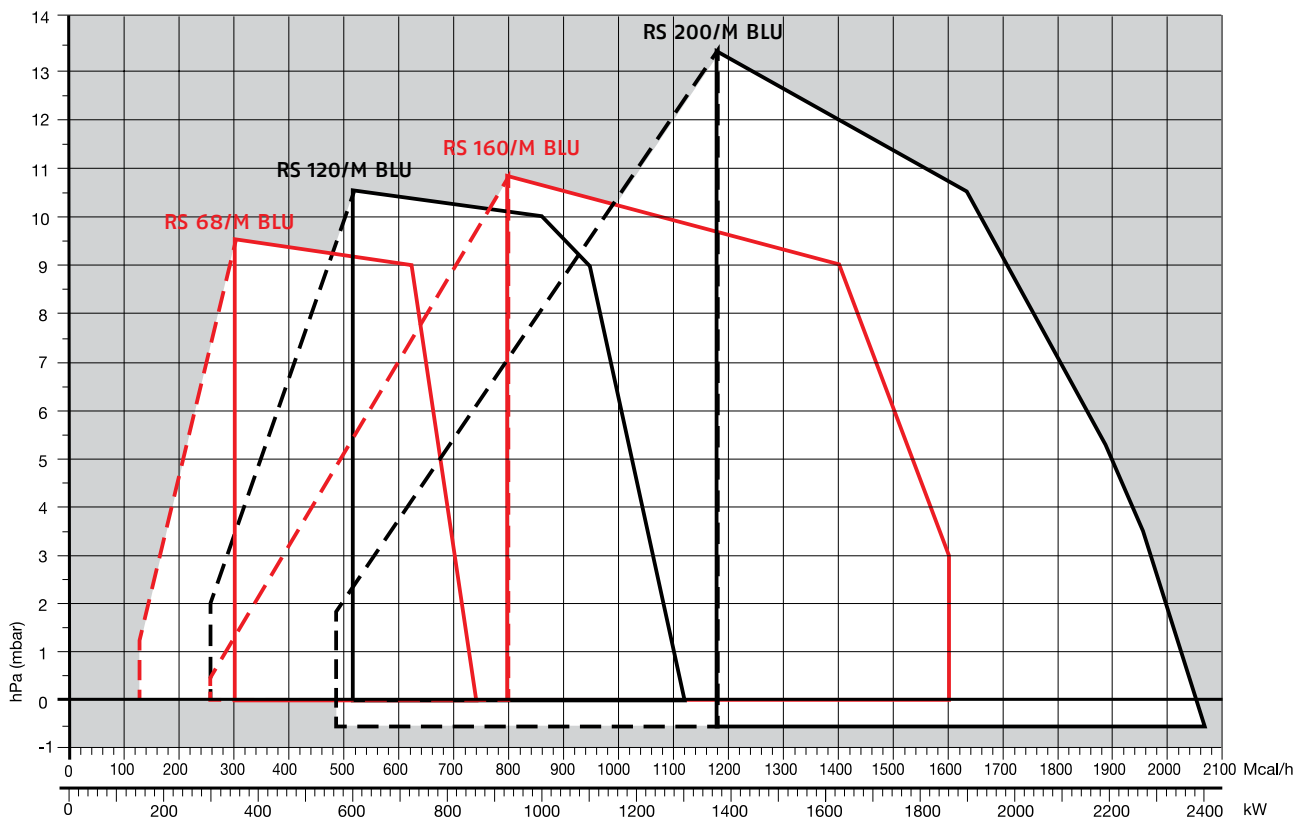
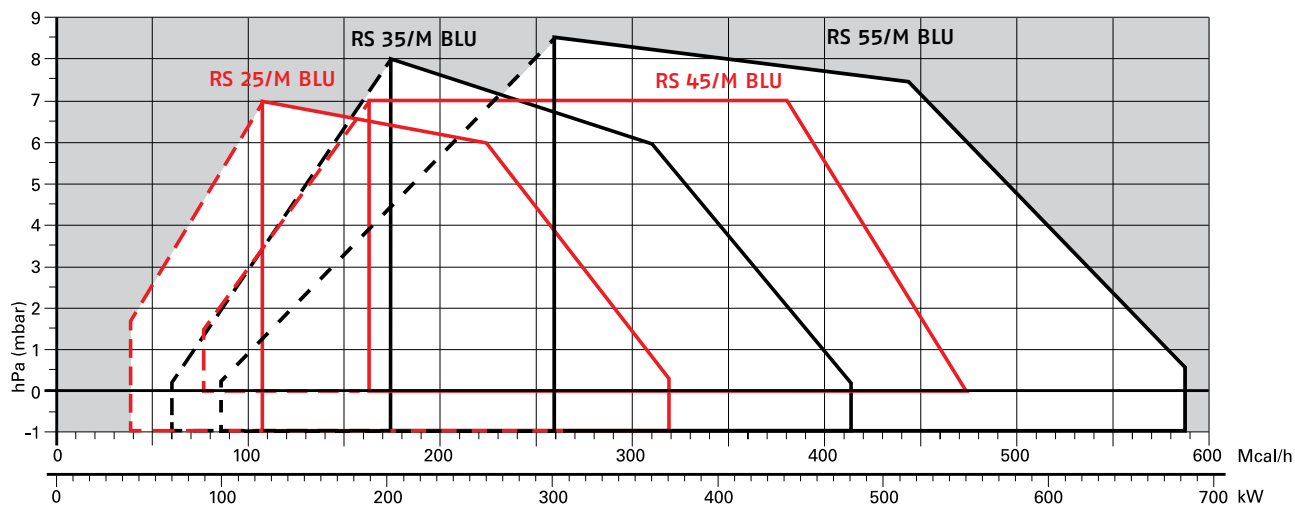

 Useful working field for choosing the burner

 Modulation range

Test conditions conforming to EN 676:
 Temperature: 20°C
 Pressure: 1013,5 mbar
 Altitude: 0 m a.s.l.

Fuel Supply

GAS TRAIN DESIGNATION

- Series: MB
 MBC
 DMV
 DMV12
 VGD
 CB
 CBH
 MV
 CG

Size:	405	407	410	412	415	420							
		65	120	300	700	1200	-	1900	3100	5000			
	505	507	510	512	-	520	525	5065	5080	50100	50125	50150	
10	15	20	32	40	-	50	-	65	80	100	125	150	
		120	220										

- Operation: /S only ON-OFF function
 /1 stage mode opening
 /2 2nd stage mode opening
 /P 1st stage mode opening with air/gas proportional regulator

- Leak detection control: - 0
 CT leak detection control device installed on the gas train
 CQ equipped with pressure switch for leak detection control

- Joint type: R threaded joint
 F standard flange ISO
 F1 square flange BS1
 F2 square flange BS2
 F3 square flange BS3 - BS4

- Electrical connection: T Terminals - Terminal strip
 SD Domestic plug
 SM Medium voltage plug

- Standard output pressure range: - without pressure governor
 0 with governor and air/gas proportional pressure
 2 with governor and output pressure up to 20 mbar
 3 with governor and output pressure up to 30 mbar
 4 with governor and output pressure up to 40 mbar
 5 with governor and output pressure up to 50 mbar
 6 with governor and output pressure up to 60 mbar
 8 with governor and output pressure up to 80 mbar
 15 with governor and output pressure up to 150 mbar

- Valve control: 0 shared
 2 separate

CB	5065	/1	CT	F	SM	3	0
----	------	----	----	---	----	---	---

BASIC DESIGNATION

EXTENDED DESIGNATION

GAS TRAINS

The burners are fitted with a butterfly valve to regulate the fuel, controlled by a variable profile cam servomotor. Fuel can be supplied either from the right or left hand sides. A maximum gas pressure switch stops the burner in case of excess pressure in the fuel line (as accessory on RS 25-35/M BLU).

The gas train can be selected to best fit system requirements depending on the fuel output and pressure in the supply line.

The gas train can be "Multibloc" type (containing the main components in a single unit) or "Composed" type (assembly of the single components).

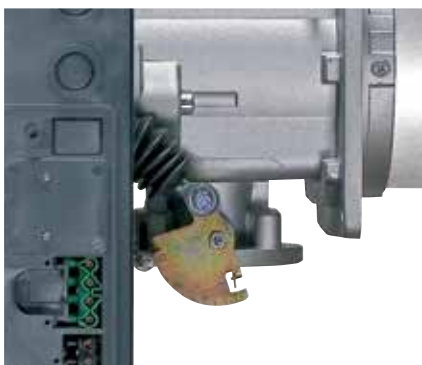

Example of the variable profile cam on RS 25-35/M BLU burners.

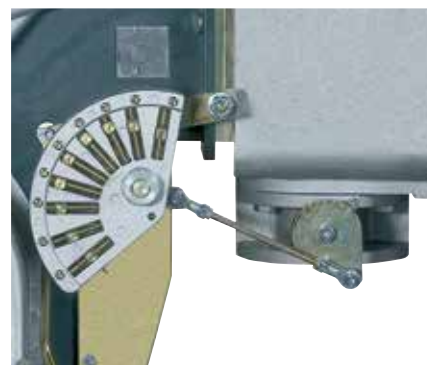

Example of the variable profile cam on RS 160/M BLU burners.

MB "THREADED"

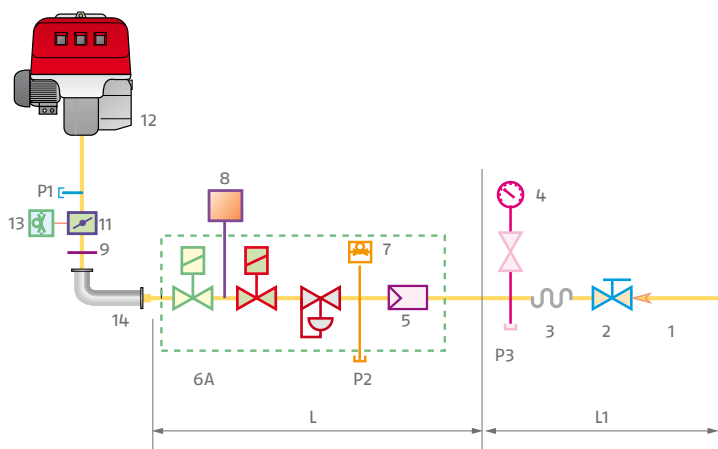

- | | |
|----|---|
| 1 | Gas input pipework |
| 2 | Manual valve |
| 3 | Anti-vibration joint |
| 4 | Pressure gauge with pushbutton cock |
| 5 | Filter |
| 6A | Includes: |
| | - filter |
| | - operation valve |
| | - safety valve |
| | - pressure adjuster |
| 7 | Minimum gas pressure switch |
| 8 | Leak detection device, supplied as an accessory or incorporated, based on the gas train code. |
| 9 | Gasket, for "flanged" versions only |
| 10 | Pressure adjuster |
| 11 | Gas adjuster butterfly valve |
| 12 | Burner |
| 13 | Maximum gas pressure switch |
| 14 | Gas train-burner adaptor, supplied separately |
| P1 | Combustion head pressure |
| P2 | Upstream pressure of valves |
| P3 | Upstream pressure of the filter |
| L | Gas train supplied separately, with the code given in the table. |
| L1 | Installer's responsibility |

MBC "THREADED"

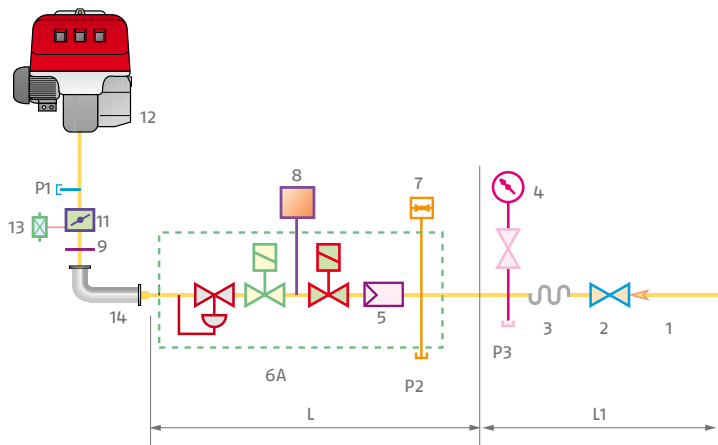

MBC "FLANGED"

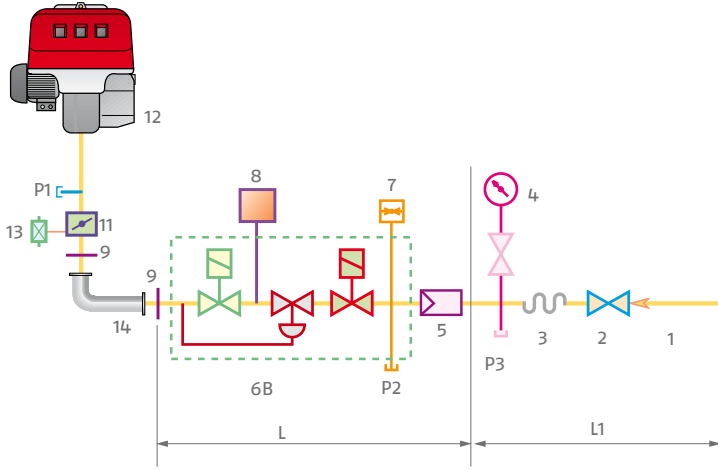

- 1 Gas input pipework
- 2 Manual valve
- 3 Anti-vibration joint
- 4 Pressure gauge with pushbutton cock
- 5 Filter
- 6B Includes:
 - operation valve
 - safety valve
 - pressure adjuster
- 6C Includes:
 - operation valve
 - safety valve
- 6D Includes:
 - operation valve
 - safety valve
- 7 Minimum gas pressure switch
- 8 Leak detection device, supplied as an accessory or incorporated, based on the gas train code.
- 9 Gasket, for "flanged" versions only
- 10 Pressure adjuster
- 11 Gas adjuster butterfly valve
- 12 Burner
- 13 Maximum gas pressure switch
- 14 Gas train-burner adaptor, supplied separately
- P1 Combustion head pressure
- P2 Upstream pressure of valves
- P3 Upstream pressure of the filter
- L Gas train supplied separately, with the code given in the table
- L1 Installer's responsibility

CB "FLANGED OR THREADED"

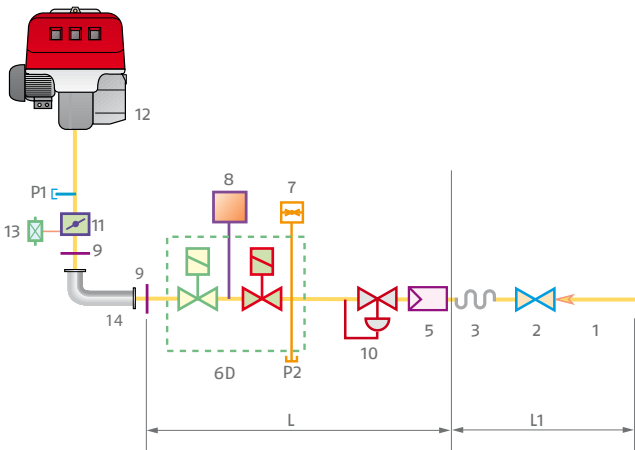

DMV "FLANGED OR THREADED"

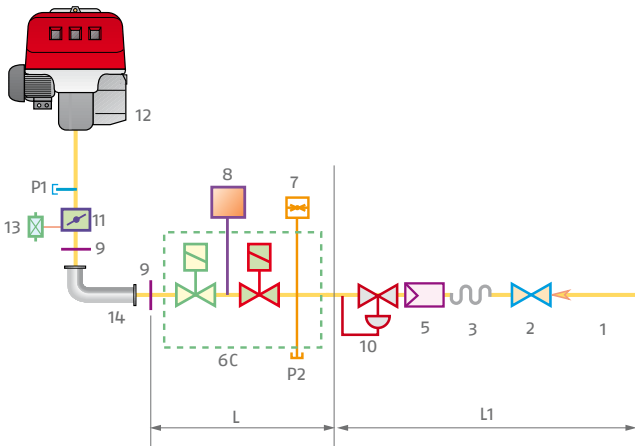

Gas trains are approved by standard EN 676 together with the burner. The overall dimensions of the gas train depends on how they are constructed. The following table shows the maximum dimensions of the gas trains that can be fitted to RS/M BLU burners, intake and outlet diameters and seal control if fitted. Please note that the seal control can be installed as an accessory, if not already installed on the gas train.

The maximum gas pressure of gas train "Multibloc" type is 360 mbar, and the one of gas train "Composed" type is 500 mbar.

The range of pressure in the MULTIBLOC with flange can be modified choosing the stabiliser spring (see gas train accessory).

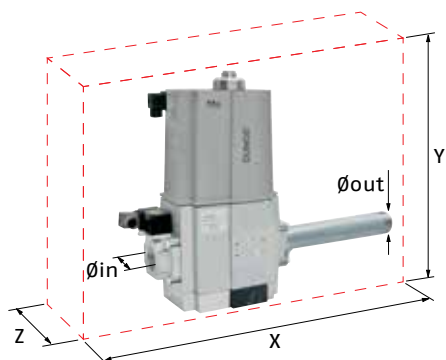

Example of gas train "MULTIBLOC" type without seal control (i.e. MBC 1200)

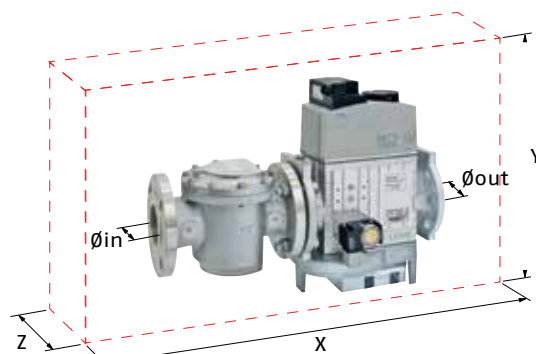

Example of gas train "COMPOSED" type without seal control (i.e. MBC 1900-3100-5000)



Example of gas train "CB" series with seal control

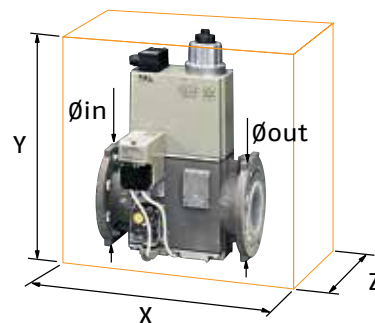

Example of gas train "DMV" series with seal control

GAS TRAIN

MODEL	CODE	Ø in	Ø out	X mm	Y mm	Z mm
MB 405/1 - RT 20	3970500					
MB 407/1 - RT 20	3970553					
MB 407/1 - RT 52	3970599					
MB 407/1 - RSM 20	3970229					
MB 410/1 - RT 52	3970258					
MB 410/1 - RT 20	3970554					
MB 410/1 - RT 52	3970600					
MB 410/1 - RSM 20	3970230					
MB 412/1 - RT 52	3970256					
MB 412/1 - RT 20	3970144					
MB 412/1 - CT RT 20	3970197					
MB 412/1 - RSM 20	3970231					
MB 415/1 - RT 30	3970180	Rp 1-1/2"	Rp 1-1/2"	523	250	100
MB 415/1 CT RT 30	3970198	Rp 1-1/2"	Rp 1-1/2"	523	250	229
MB 415/1 - RT 52	3970250	Rp 1-1/2"	Rp 1-1/2"	523	250	100
MB 415/1 CT RT 52	3970253	Rp 1-1/2"	Rp 1-1/2"	523	250	229
MB 415/1 RSM 30	3970232	Rp 1-1/2"	Rp 1-1/2"	523	250	100
MB 420/1 RT 30	3970181	Rp 2"	Rp 2"	523	289	100
MB 420/1 CT RT 30	3970182	Rp 2"	Rp 2"	523	289	229
MB 420/1 RT 52	3970257	Rp 2"	Rp 2"	523	289	100
MB 420/1 CT RT 52	3970252	Rp 2"	Rp 2"	523	289	229
MB 420/1 RSM 30	3970233	Rp 2"	Rp 2"	523	289	100
MB 420/1 CT RSM 30	3970234	Rp 2"	Rp 2"	523	289	229

GAS TRAIN						
MODEL	CODE	∅ in	∅ out	X mm	Y mm	Z mm
MBC 1200/1 - RSM 60	3970221	Rp 2"	Rp 2"	528	424	161
MBC 1200/1 CT RSM 60	3970225	Rp 2"	Rp 2"	528	424	290
MBC 1900/1 - FSM 40	3970222	DN 65	DN 65	613	430	237
MBC 1900/1 CT FSM 40	3970226	DN 65	DN 65	613	430	298
MBC 3100/1 - FSM 40	3970223	DN 80	DN 80	633	500	240
MBC 3100/1 CT FSM 40	3970227	DN 80	DN 80	633	500	319
MBC 5000/1 - FSM 80	3970224	DN 100	DN 100	733	576	280
MBC 5000/1 CT FSM 80	3970228	DN 100	DN 100	733	576	348

GAS TRAIN						
MODEL	CODE	∅ in	∅ out	X mm	Y mm	Z mm
CB 512/1 - RSM 30	3970145	Rp 1-1/2"	Rp 1-1/2"	891	261	245
CB 512/1 - CT RSM 30	20045589	Rp 1-1/2"	Rp 1-1/2"	891	261	245
CB 520/1 - RSM 30	3970146	Rp 2"	Rp 2"	986	328	255
CB 520/1 - CT RSM 30	3970160	Rp 2"	Rp 2"	986	328	255
CB 525/1 - RSM 30	20044659	Rp 2"	Rp 2"	1025	356	285
CB 525/1 - CT RSM 30	20044660	Rp 2"	Rp 2"	1025	356	285
CB 5065/1 - FSM 30	3970147	DN 65	DN 65	906	356	285
CB 5065/1 CT FSM 30	3970161	DN 65	DN 65	906	356	285
CB 5080/1 - FSM 30	3970148	DN 80	DN 80	934	416	285
CB 5080/1 CT FSM 30	3970162	DN 80	DN 80	934	416	285
CB 50100/1 - FSM 30	3970149	DN 100	DN 100	1054	501	350
CB 50100/1 CT FSM 30	3970163	DN 100	DN 100	1054	501	350
CB 50125/1 - FSM 30	20015871	DN 125	DN 125	1164	780	400
CB 50125/1 CT FSM 30	3970196	DN 125	DN 125	1164	780	400

GAS TRAIN						
MODEL	CODE	∅ in	∅ out	X mm	Y mm	Z mm
DMV 512/1 - RSM - 0	20043035	Rp 1-1/2"	Rp 1-1/2"	490	292	245
DMV 512/1 -CT RSM - 0	20043036	Rp 1-1/2"	Rp 1-1/2"	490	292	245
DMV 520/1 - RSM - 0	20043038	Rp 2"	Rp 2"	490	292	255
DMV 520/1 CT RSM - 0	20043039	Rp 2"	Rp 2"	490	292	255
DMV 525/1 - RSM - 0	20043053	Rp 2"	Rp 2"	530	338	270
DMV 525/1 CT RSM - 0	20043054	Rp 2"	Rp 2"	530	338	270
DMV 5065/1 - FSM - 0	20043041	DN 65	DN 65	290	338	270
DMV 5065/1 CT FSM - 0	20043042	DN 65	DN 65	290	338	270
DMV 5080/1 - FSM - 0	20043044	DN 80	DN 80	310	397	290
DMV 5080/1 CT FSM - 0	20043045	DN 80	DN 80	310	397	290
DMV 50100/1 - FSM - 0	20043047	DN 100	DN 100	350	449	307
DMV 50100/1 CT FSM - 0	20043048	DN 100	DN 100	350	449	307
DMV 50125/1 - FSM - 0	20043050	DN 125	DN 125	400	554	333
DMV 50125/1 CT FSM - 0	20043051	DN 125	DN 125	400	554	333

Pressure Drop Diagram

The diagrams indicate the minimum pressure drop of the burners with the various gas trains that can be matched with them; at the value of these pressure drop add the combustion chamber pressure. The value thus calculated represents the minimum required input pressure to the gas train.

The minimum input gas pressure required is 15 mbar while burner operating. In particular, the pressure difference between gas train upstream and downstream has to remain always over pressure drop values indicated below.

RS 25/M (NATURAL GAS)

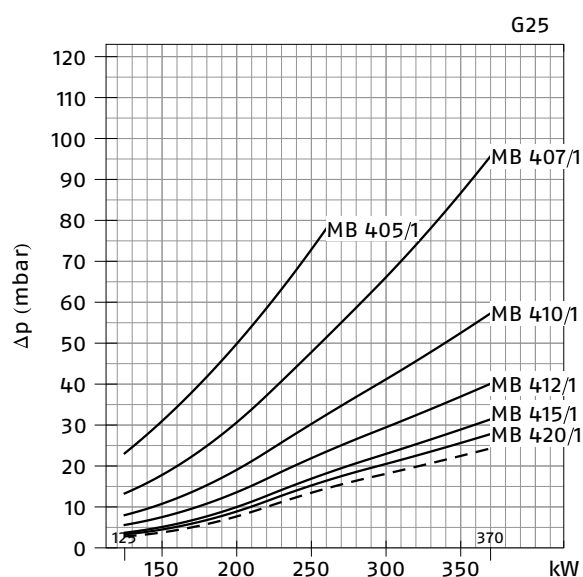
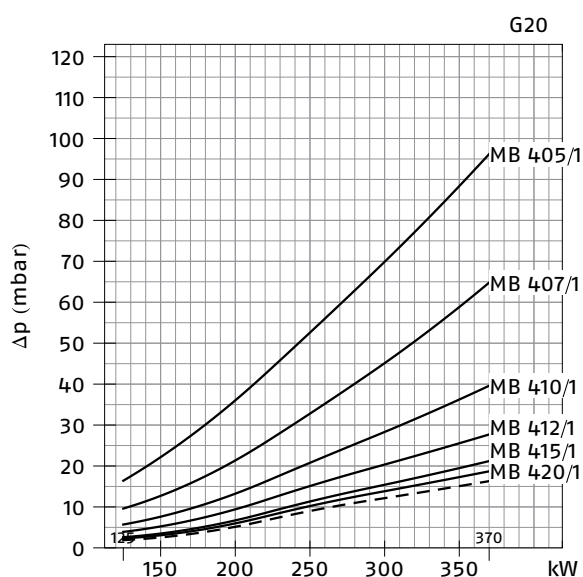

RS 25/M (NATURAL GAS)

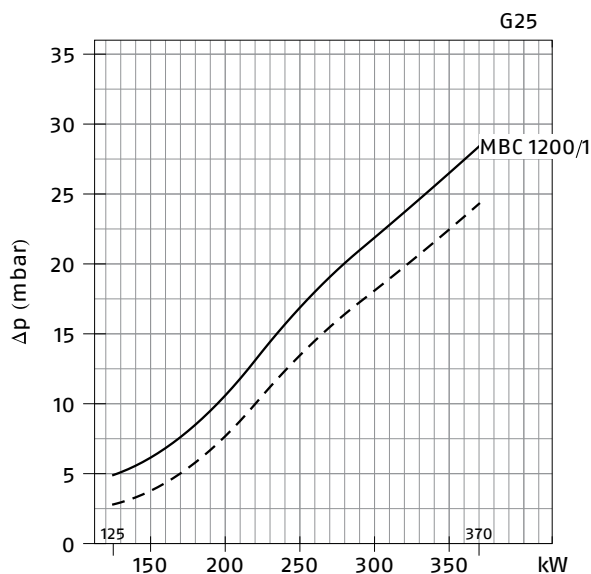
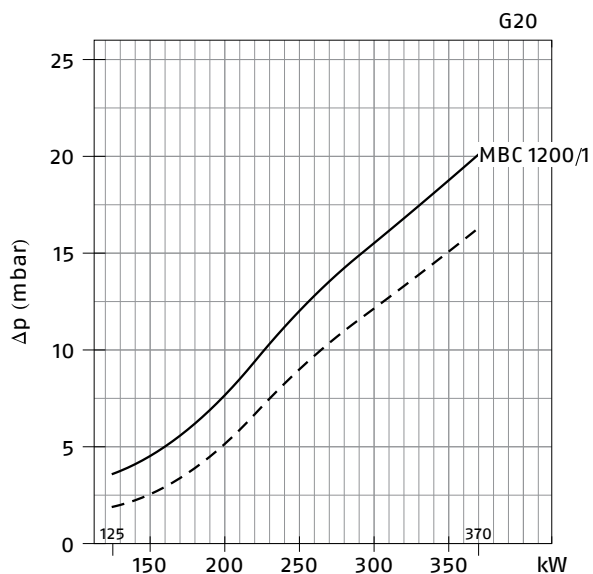

- Combustion head + gas butterfly valve + gas train
- - - Combustion head + gas butterfly valve

RS 25/M (NATURAL GAS)

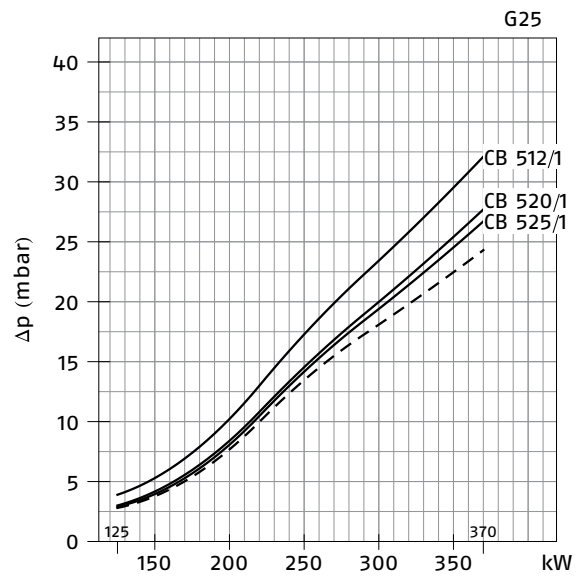
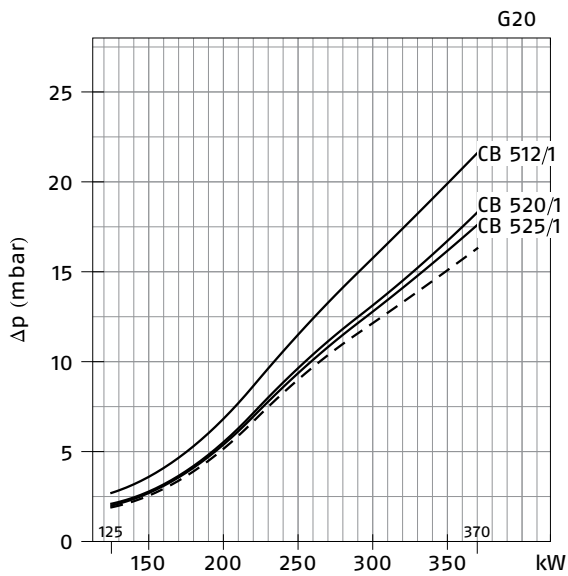

RS 25/M (NATURAL GAS)

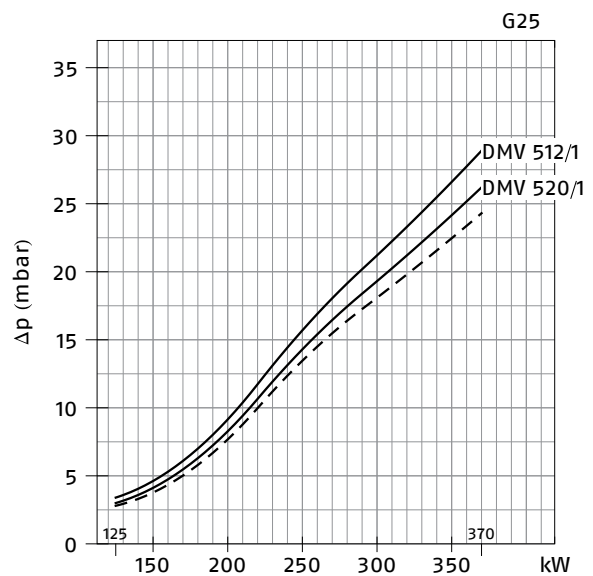
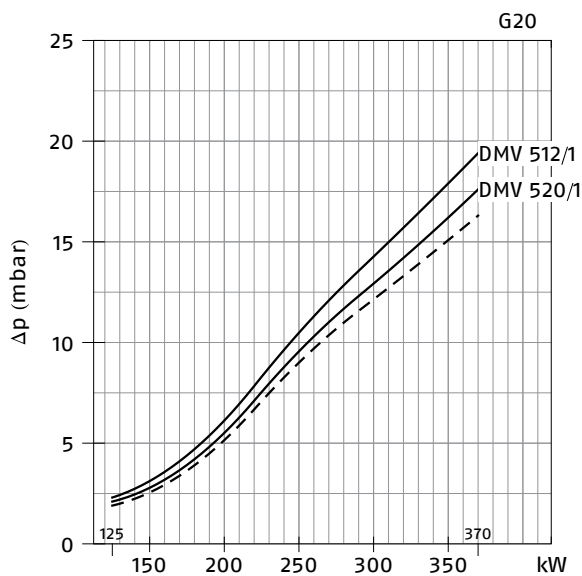

— Combustion head + gas butterfly valve + gas train
 - - - Combustion head + gas butterfly valve

RS 35/M (NATURAL GAS)

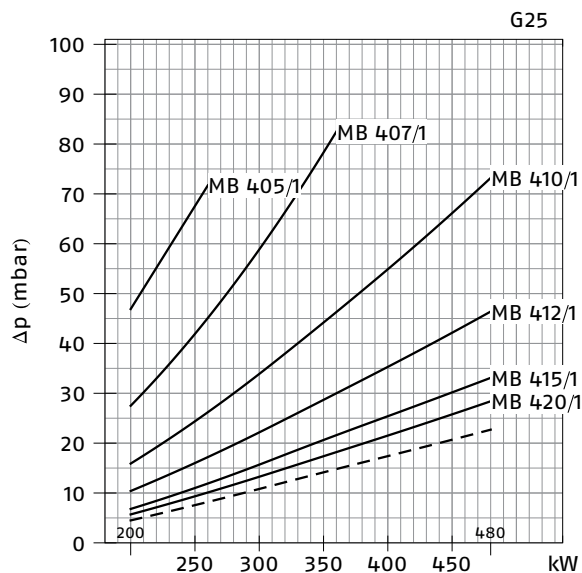
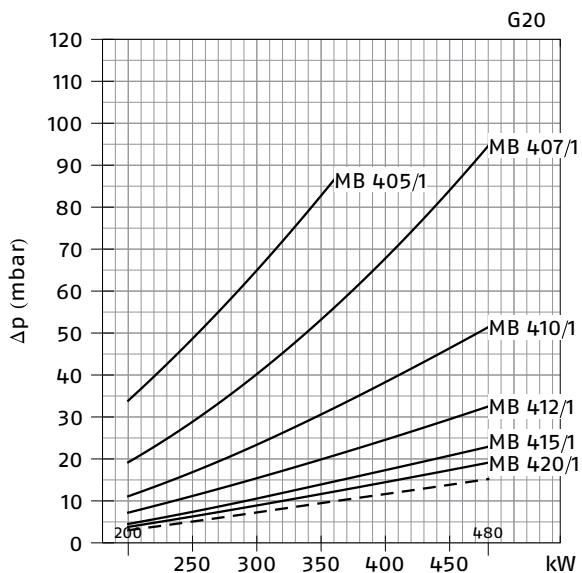

RS 35/M (NATURAL GAS)

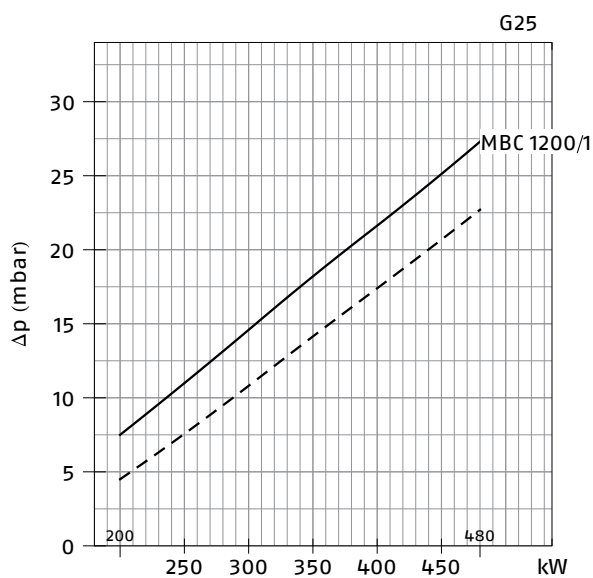
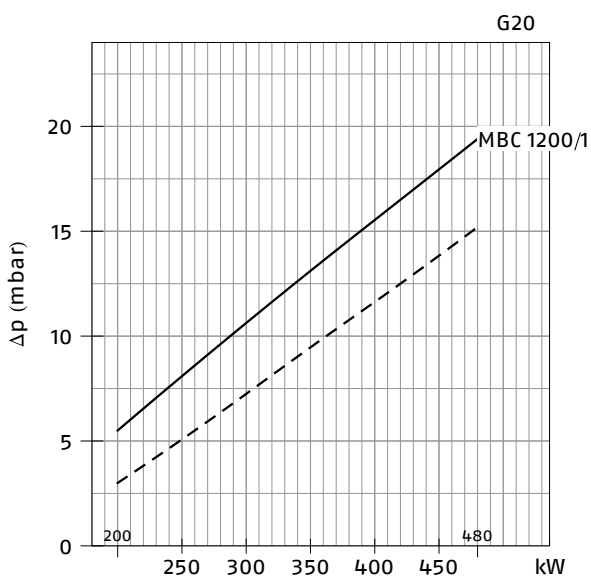

- Combustion head + gas butterfly valve + gas train
- - - Combustion head + gas butterfly valve

RS 35/M (NATURAL GAS)

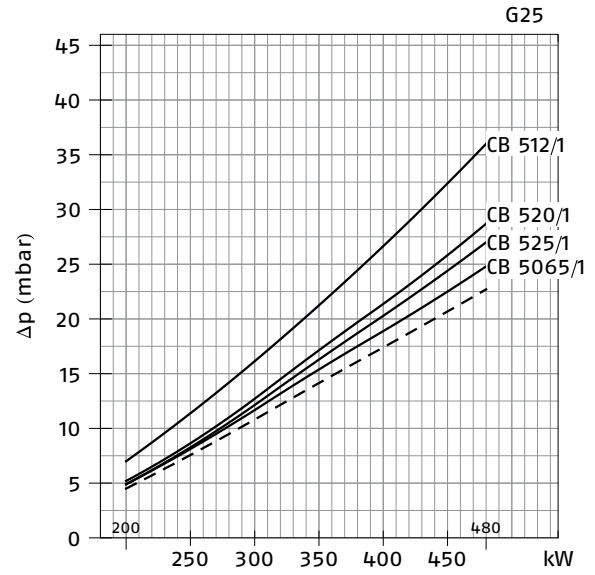
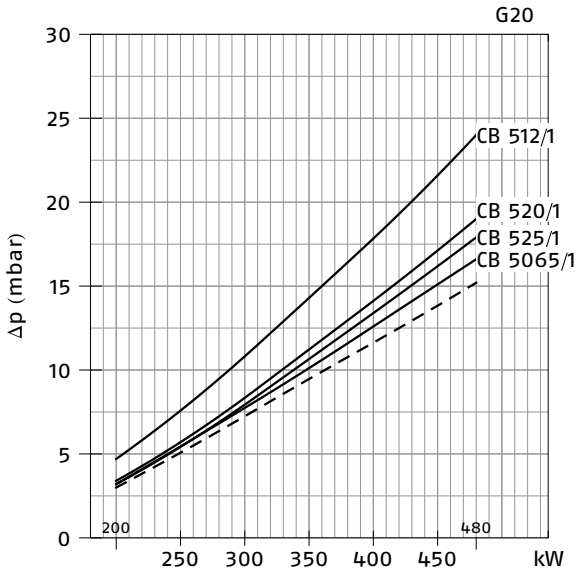

RS 35/M (NATURAL GAS)

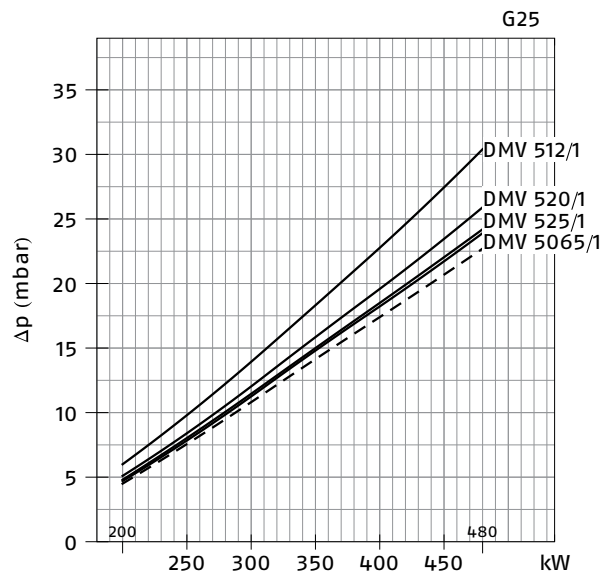
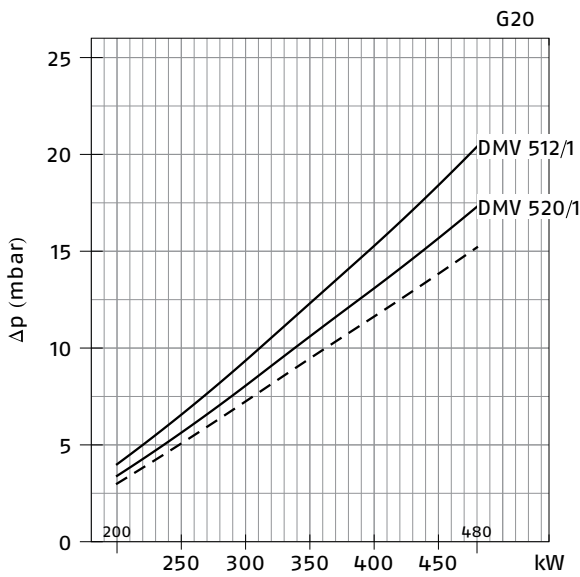

— Combustion head + gas butterfly valve + gas train
 - - - Combustion head + gas butterfly valve

RS 45/M (NATURAL GAS)

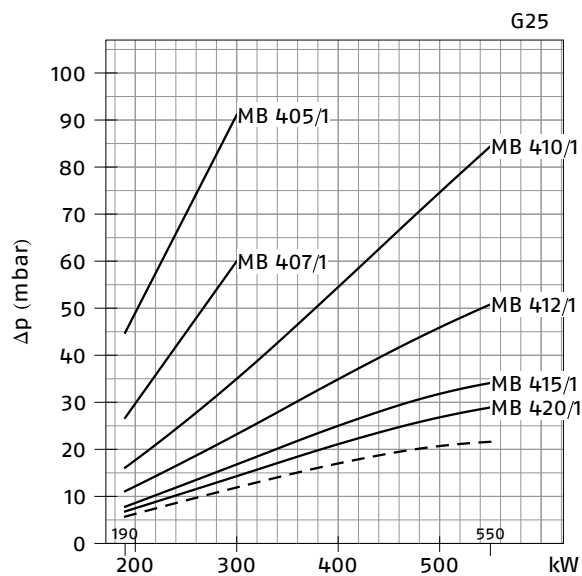
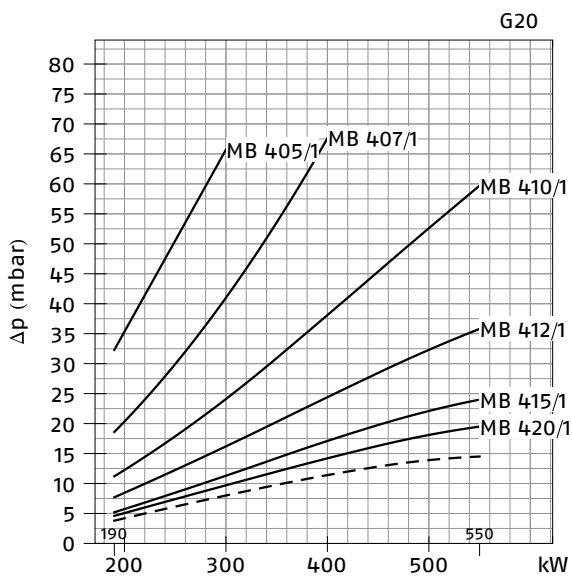

RS 500/M (NATURAL GAS)

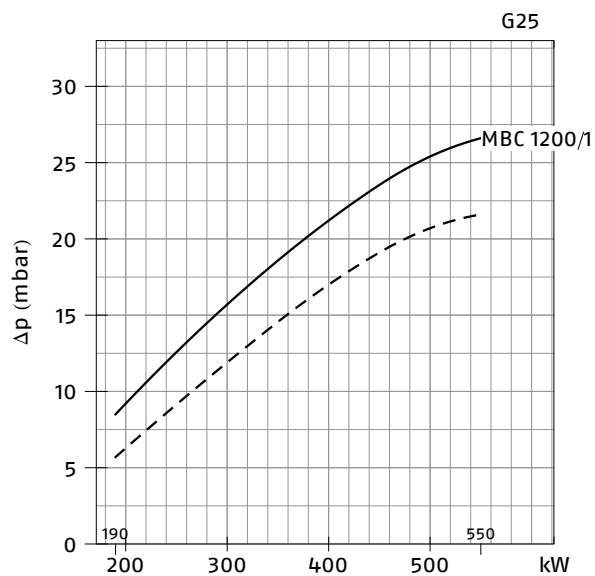
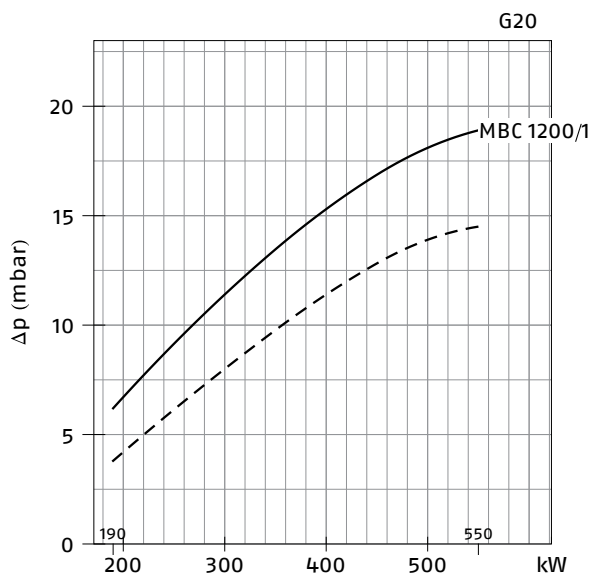

— Combustion head + gas butterfly valve + gas train
 - - - Combustion head + gas butterfly valve

RS 45/M (NATURAL GAS)

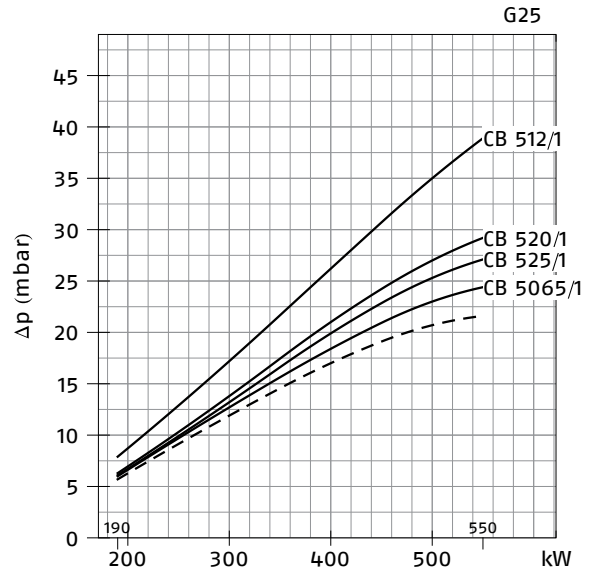
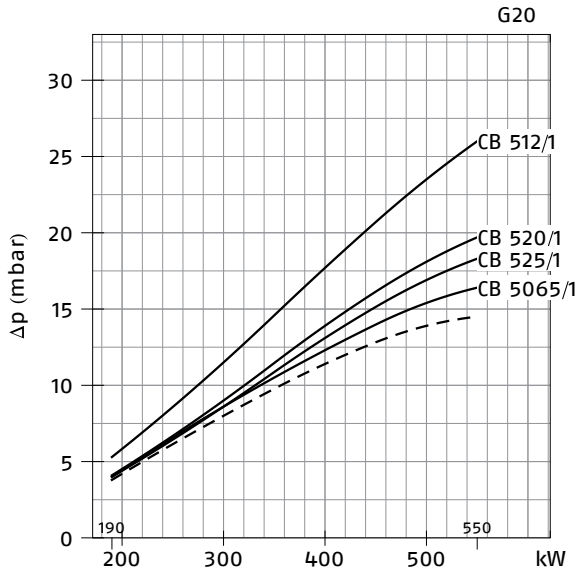

RS 45/M (NATURAL GAS)

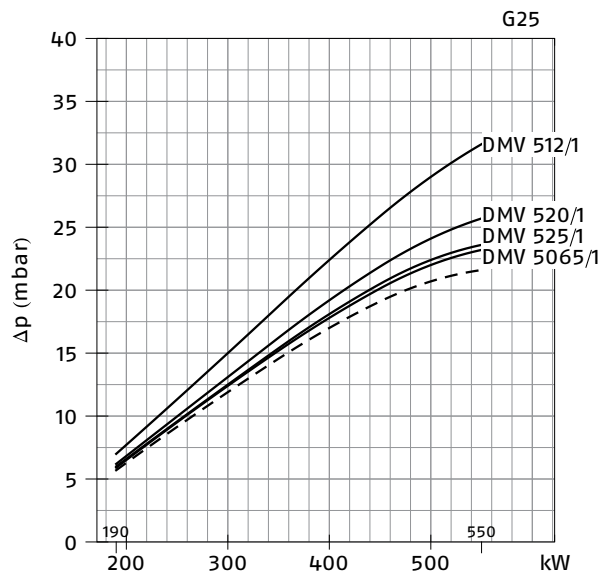
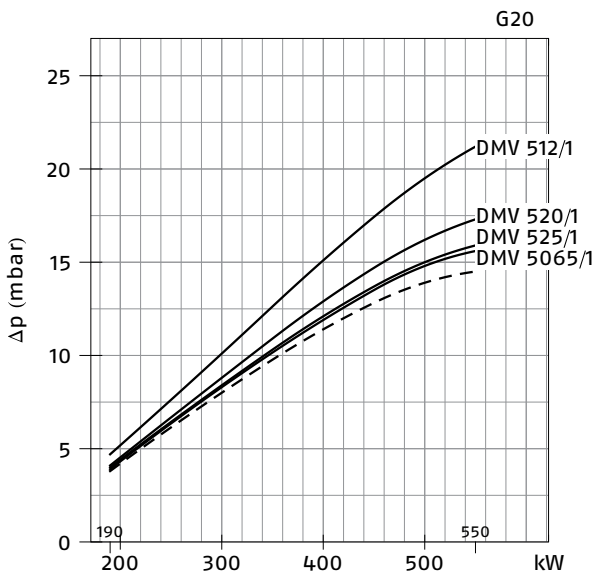

— Combustion head + gas butterfly valve + gas train
 - - - Combustion head + gas butterfly valve

RS 55/M (NATURAL GAS)

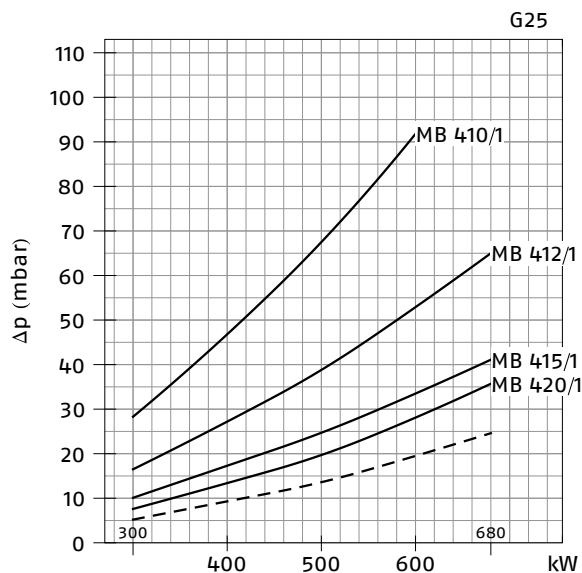
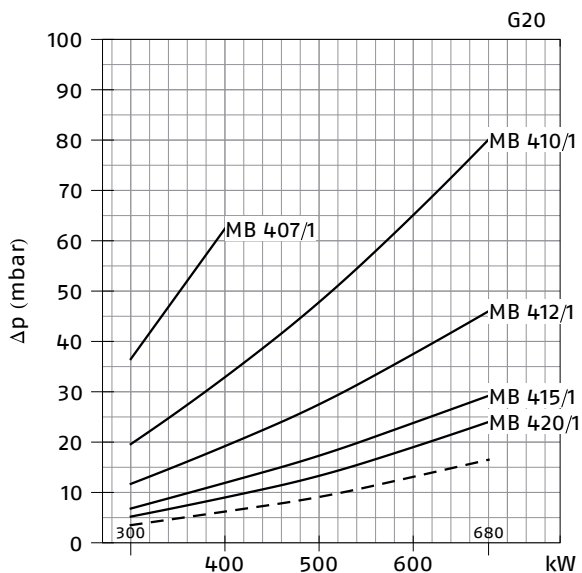

RS 55/M (NATURAL GAS)

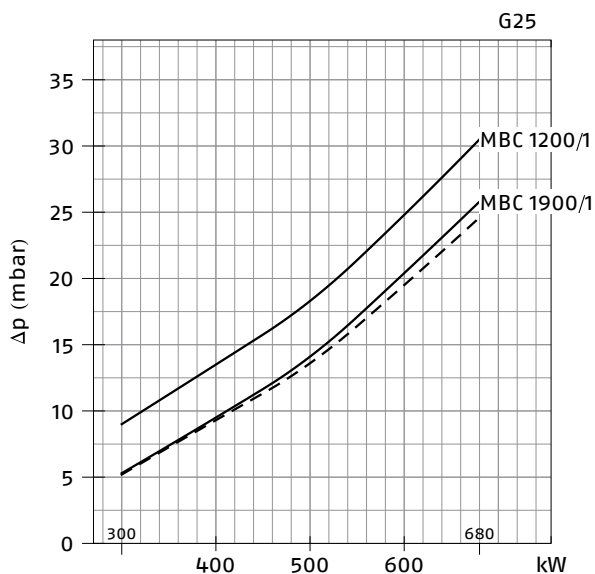
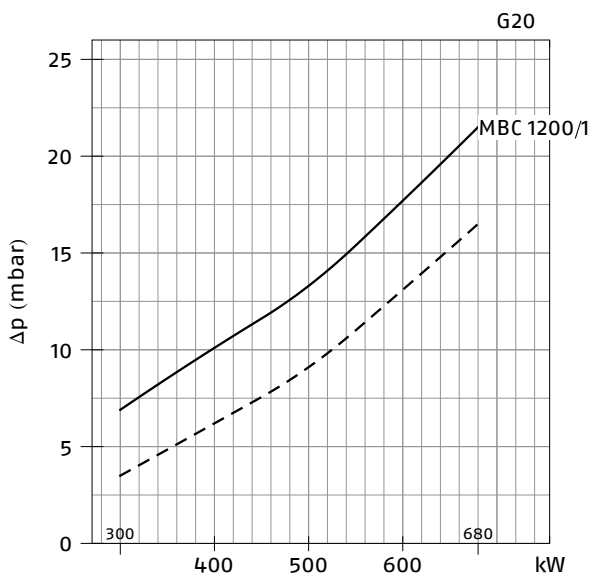

- Combustion head + gas butterfly valve + gas train
- - - Combustion head + gas butterfly valve

RS 55/M (NATURAL GAS)

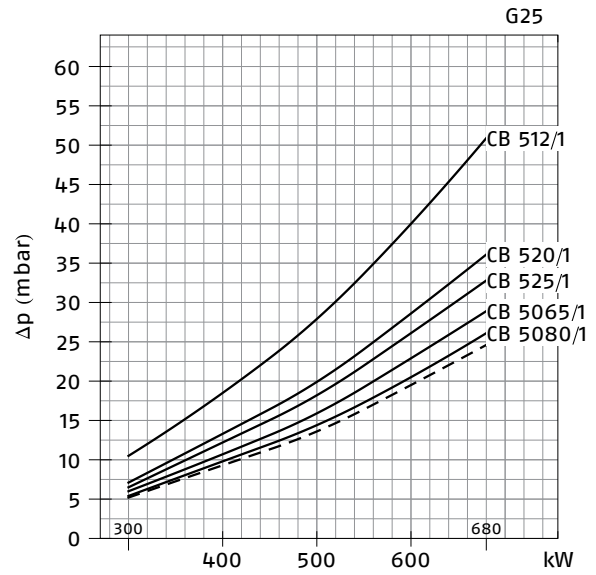
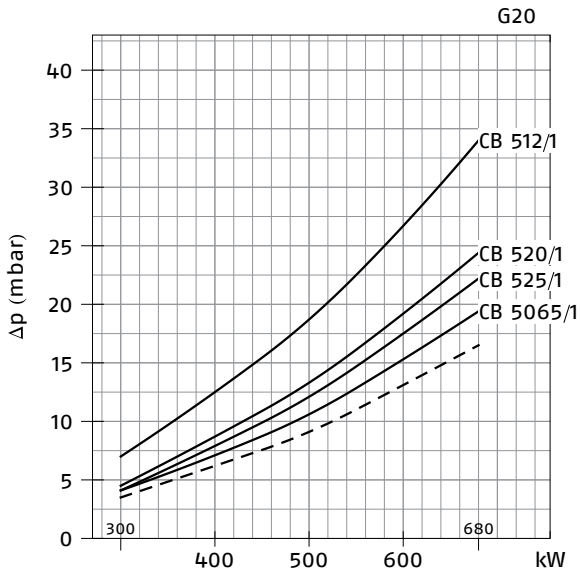

RS 55/M (NATURAL GAS)

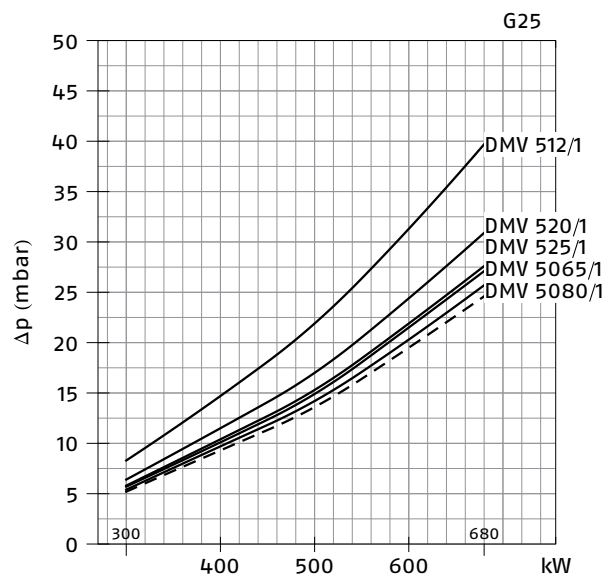
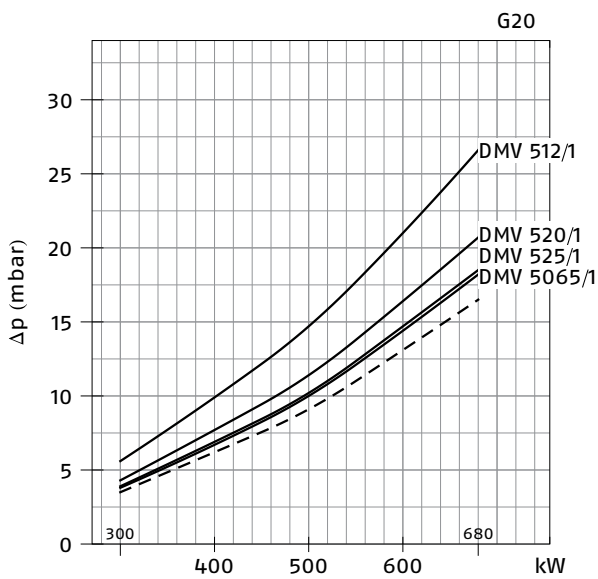

— Combustion head + gas butterfly valve + gas train
 - - - Combustion head + gas butterfly valve

RS 68/M (NATURAL GAS)

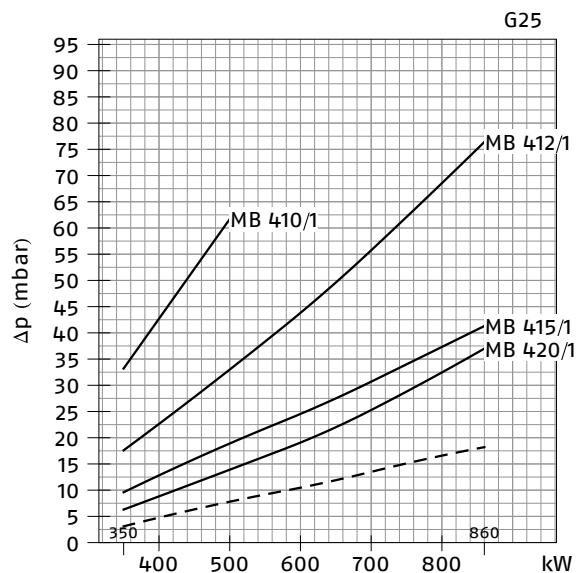
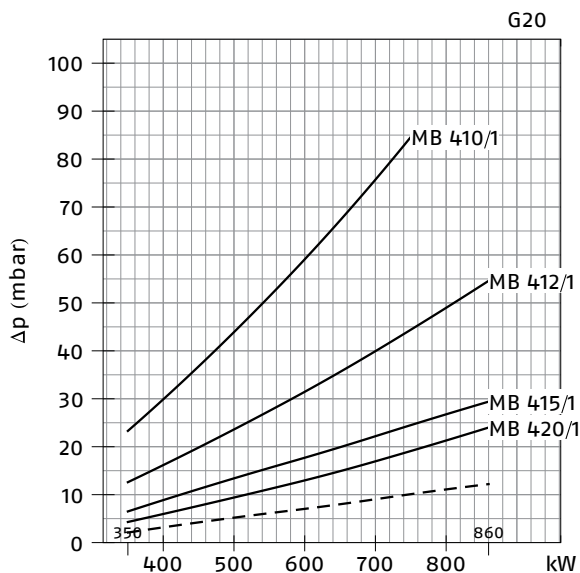

RS 68/M (NATURAL GAS)

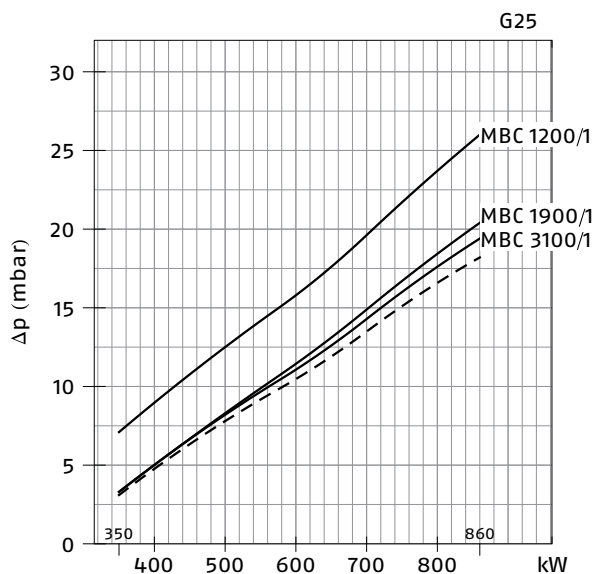
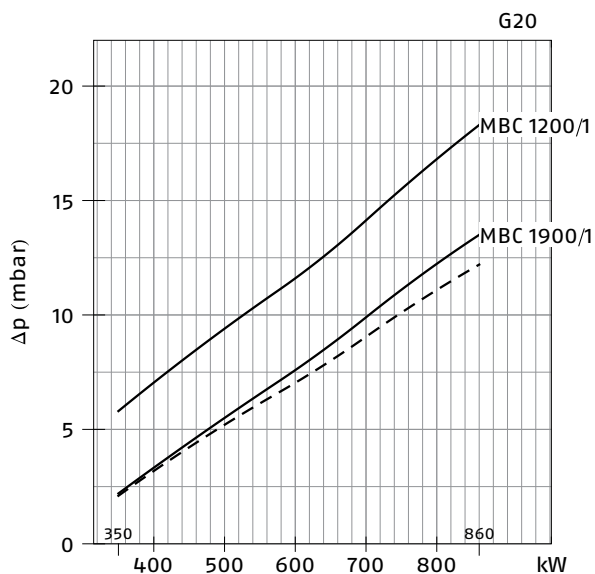

- Combustion head + gas butterfly valve + gas train
- - - Combustion head + gas butterfly valve

RS 68/M (NATURAL GAS)

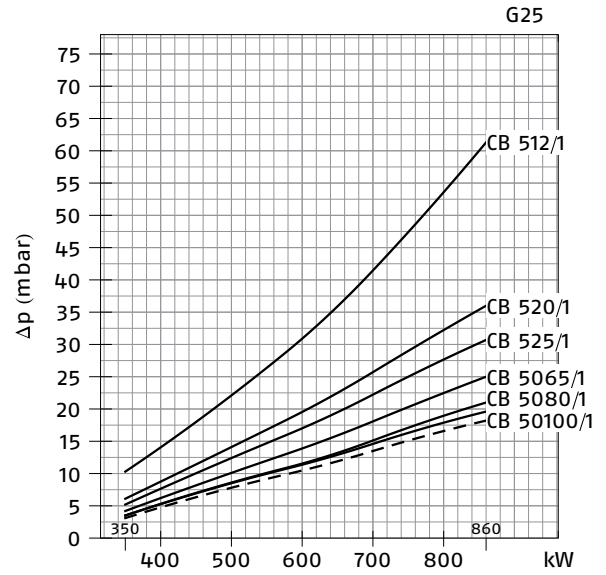
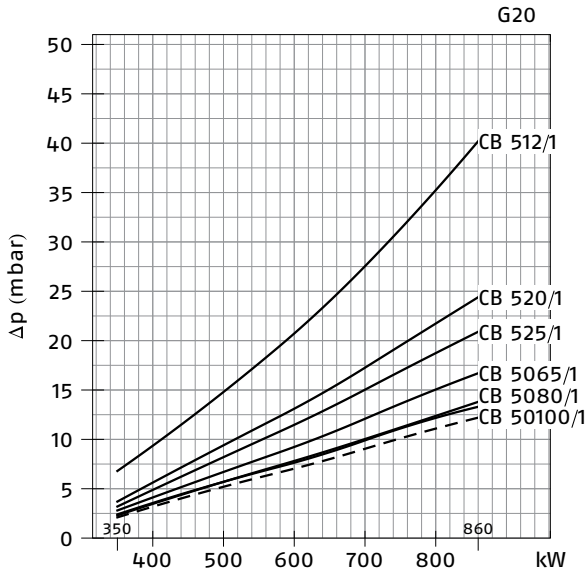

RS 68/M (NATURAL GAS)

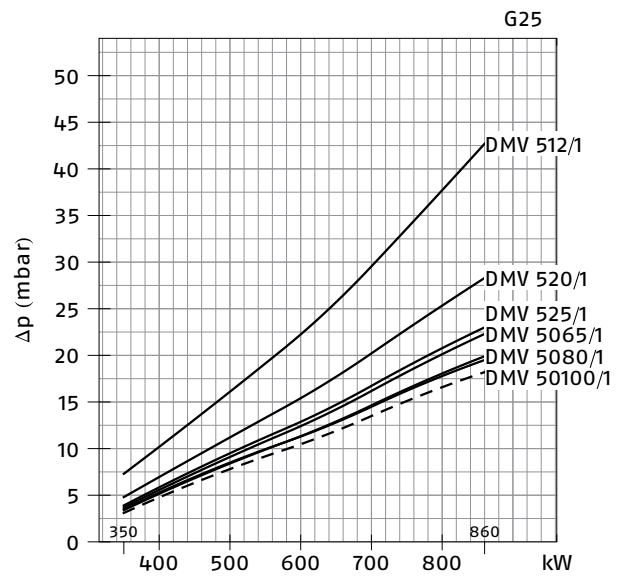
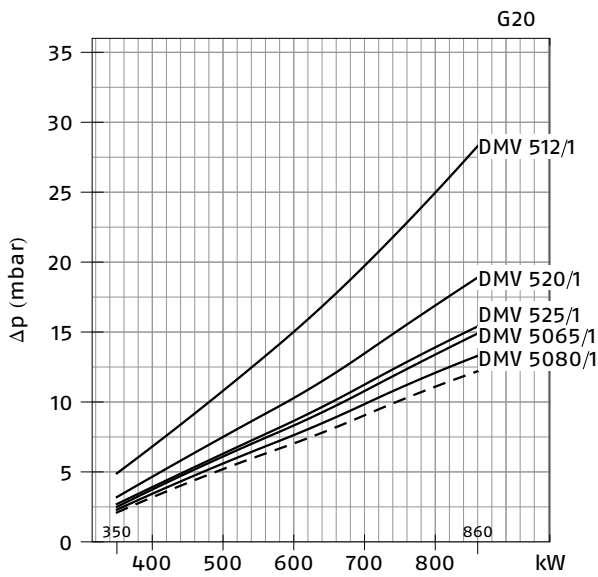

— Combustion head + gas butterfly valve + gas train
 - - - Combustion head + gas butterfly valve

RS 120/M (NATURAL GAS)

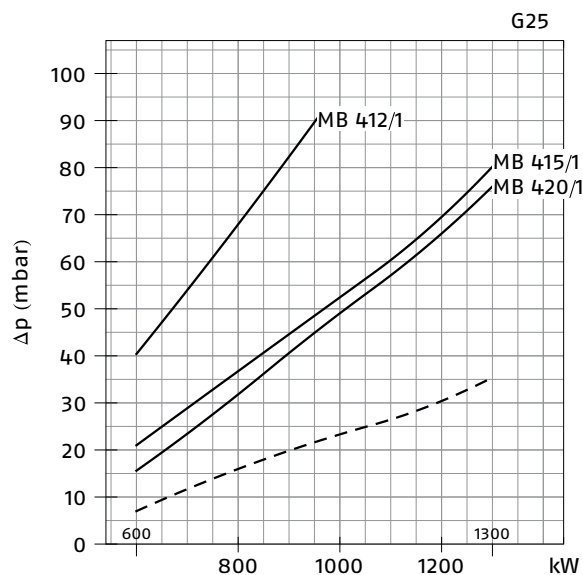
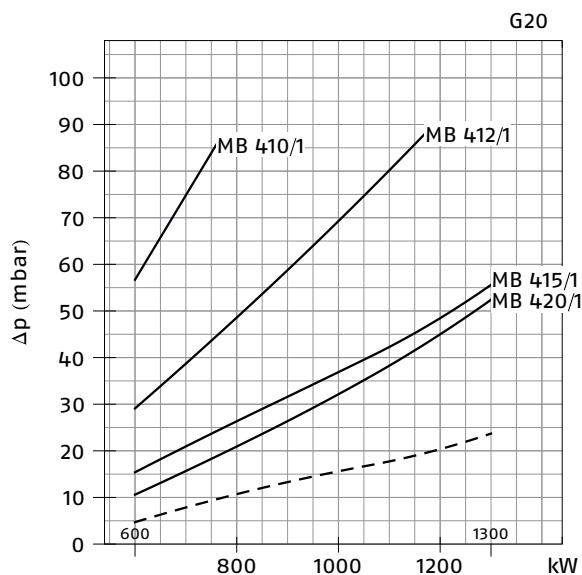

RS 120/M (NATURAL GAS)

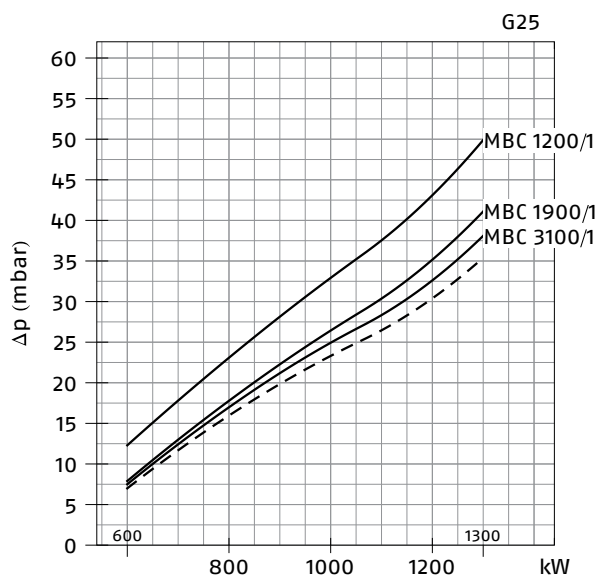
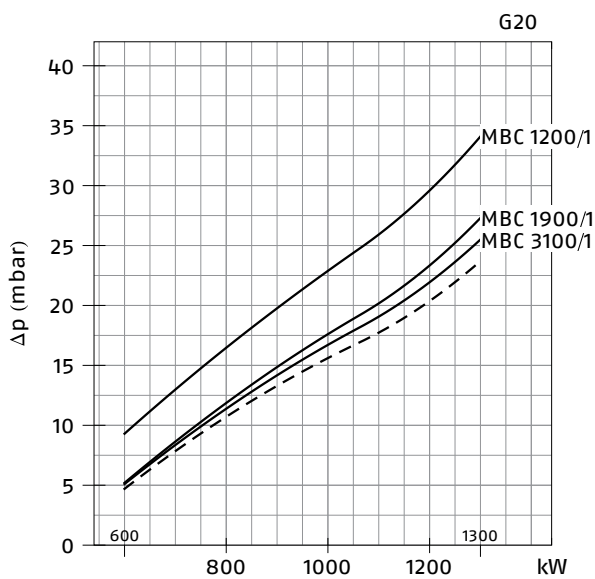

- Combustion head + gas butterfly valve + gas train
- - - Combustion head + gas butterfly valve

RS 120/M (NATURAL GAS)

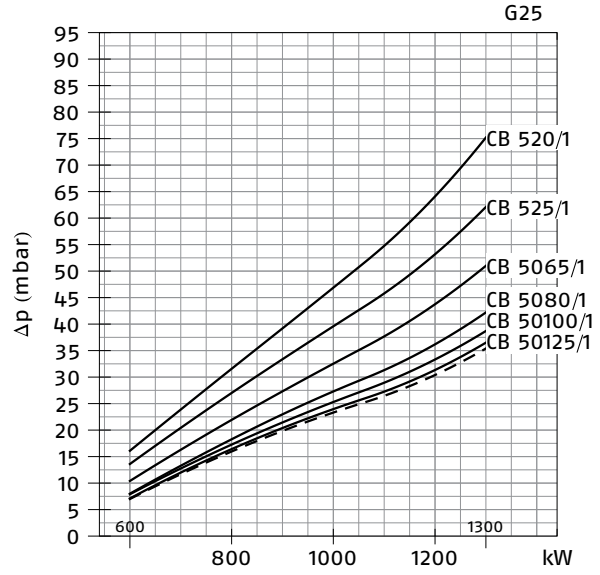
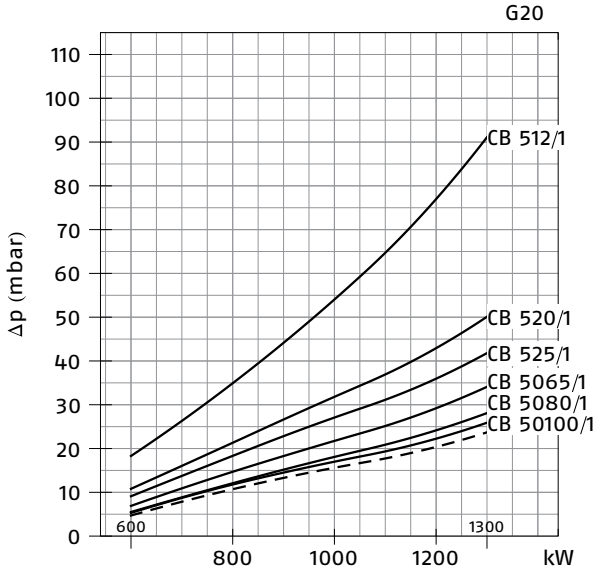

RS 120/M (NATURAL GAS)

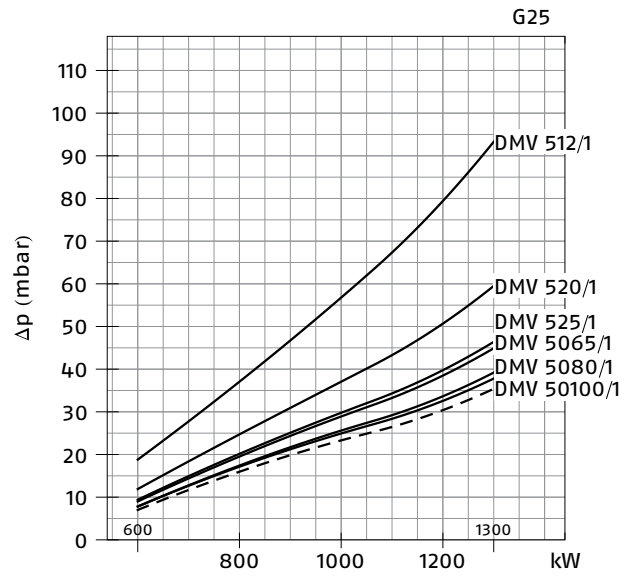
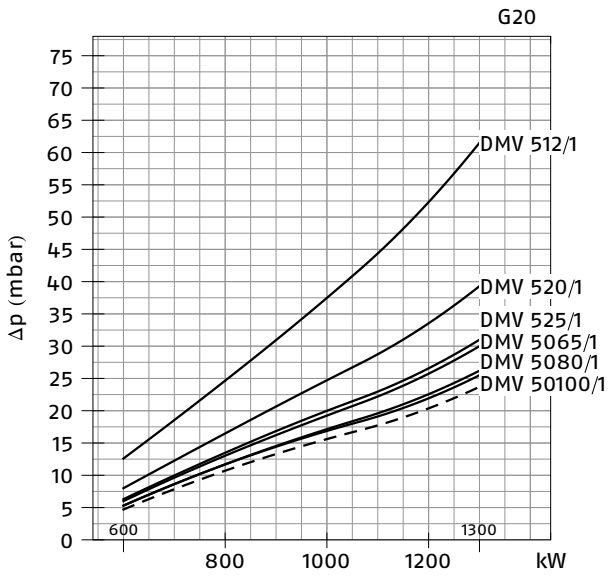

- Combustion head + gas butterfly valve + gas train
- - - Combustion head + gas butterfly valve

RS 160/M (NATURAL GAS)

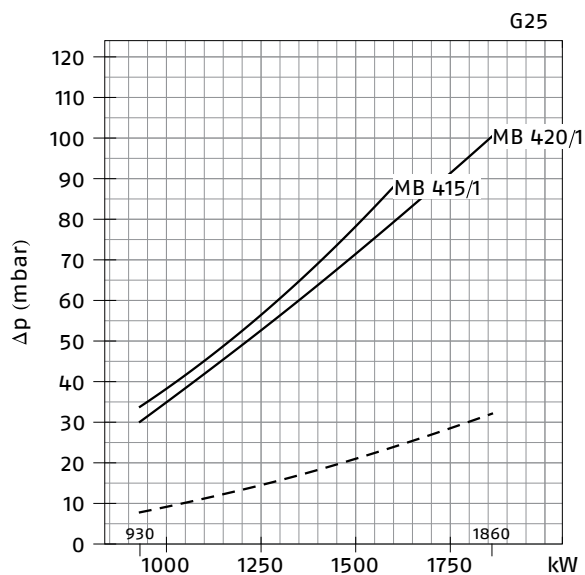
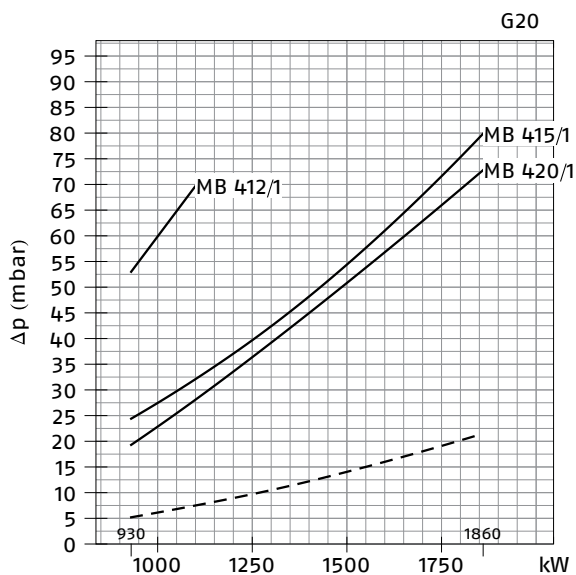

RS 160/M (NATURAL GAS)

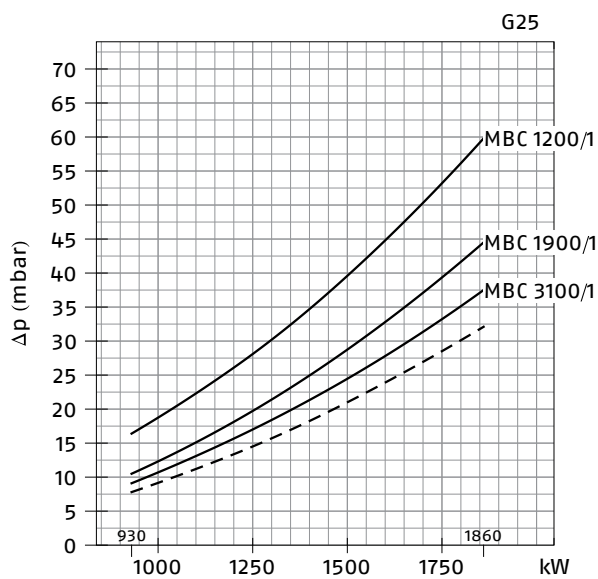
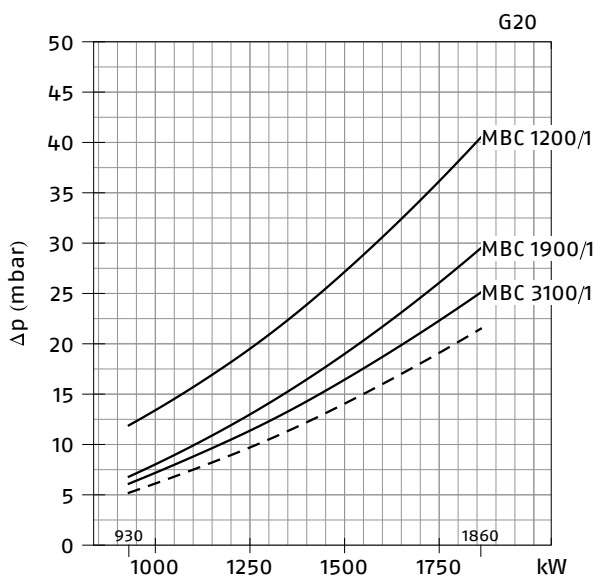

- Combustion head + gas butterfly valve + gas train
- - - Combustion head + gas butterfly valve

RS 160/M (NATURAL GAS)

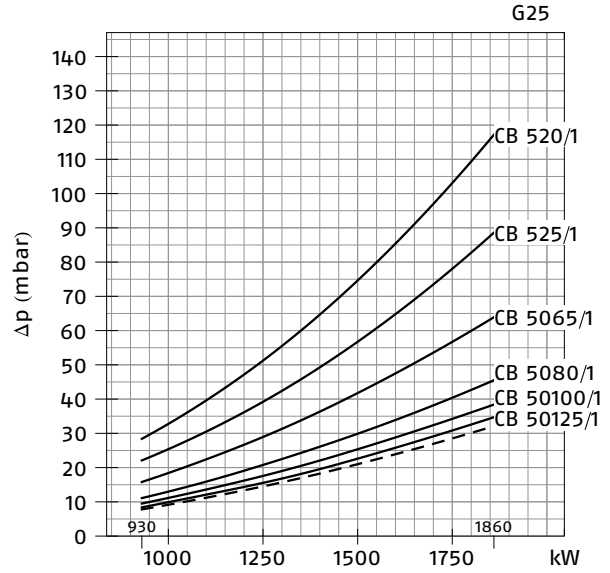
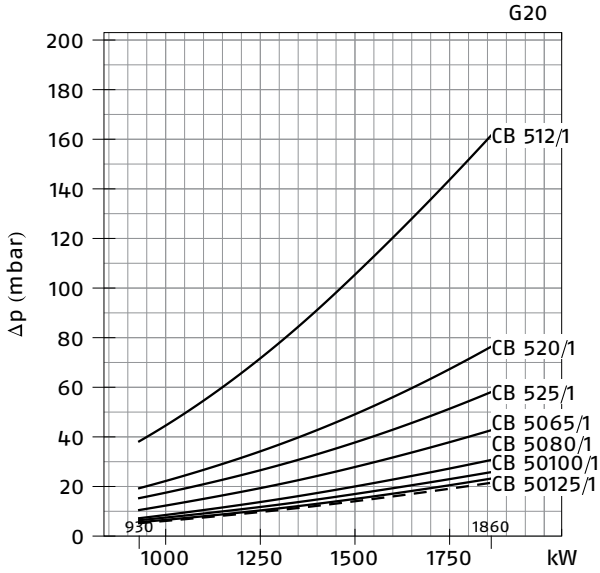

RS 160/M (NATURAL GAS)

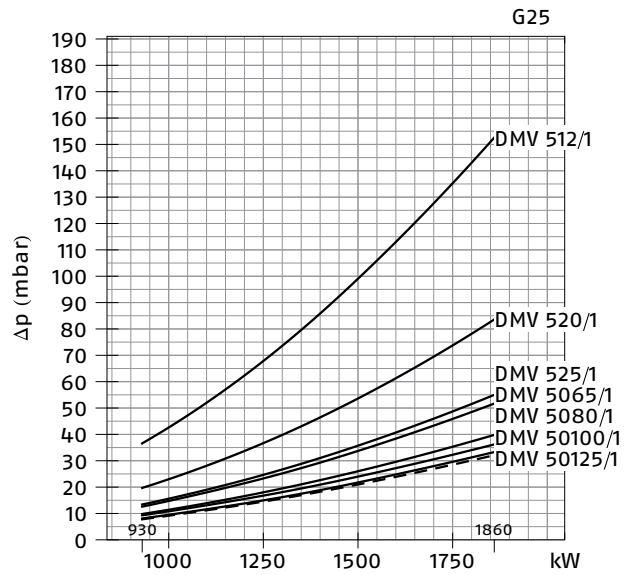
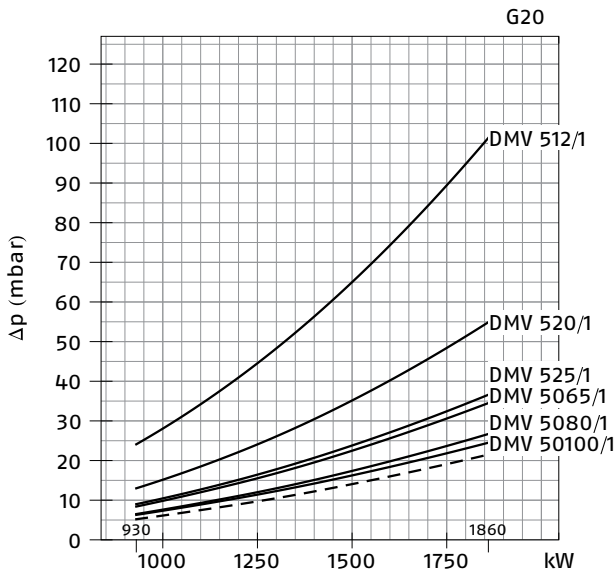

— Combustion head + gas butterfly valve + gas train
 - - - Combustion head + gas butterfly valve

RS 200/M (NATURAL GAS)

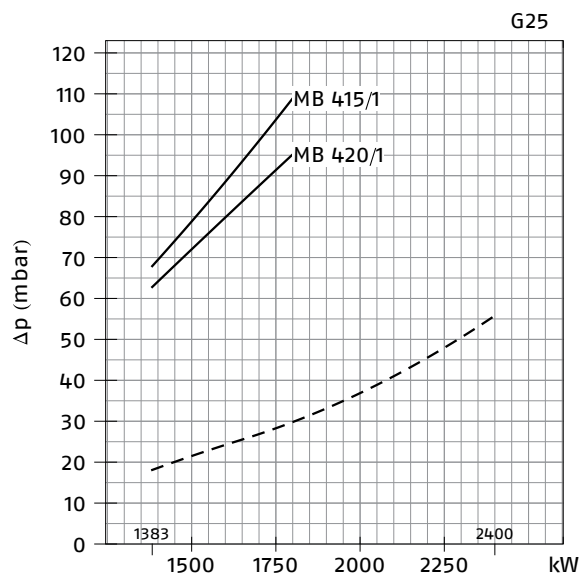
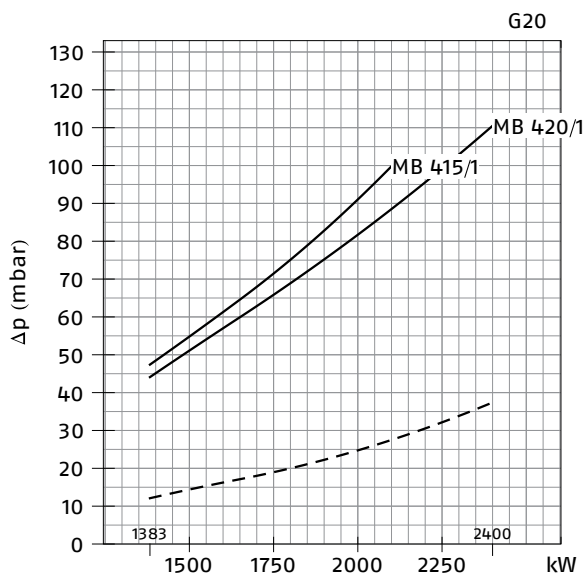

RS 200/M (NATURAL GAS)

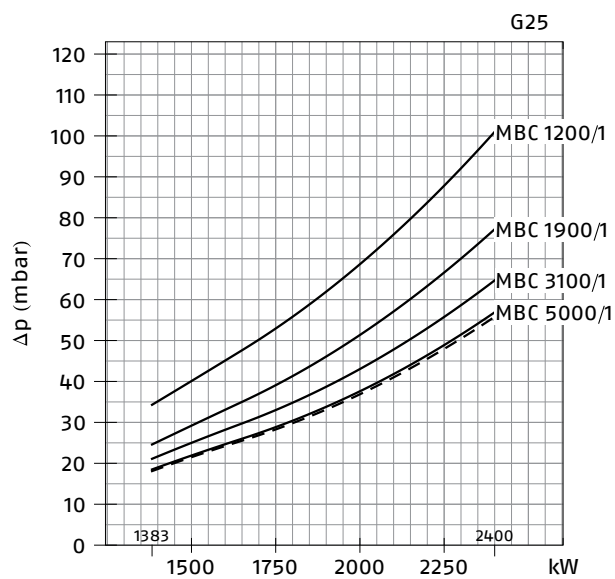
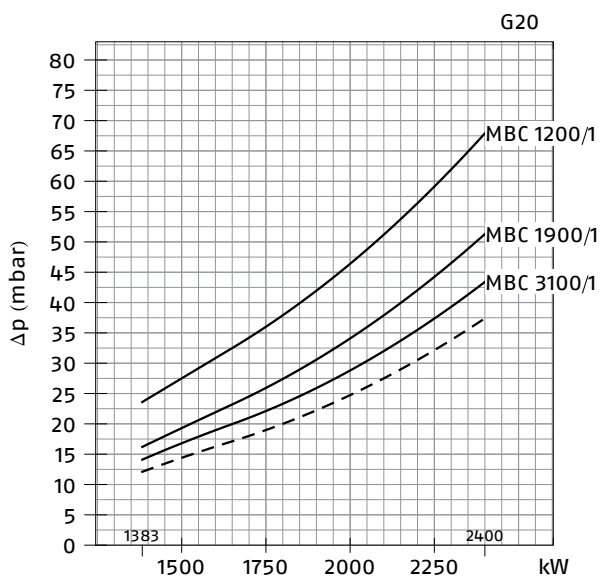

- Combustion head + gas butterfly valve + gas train
- - - Combustion head + gas butterfly valve

RS 200/M (NATURAL GAS)

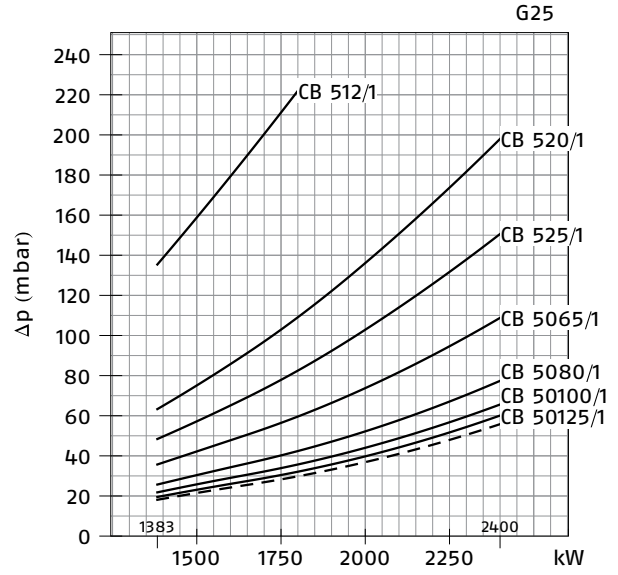
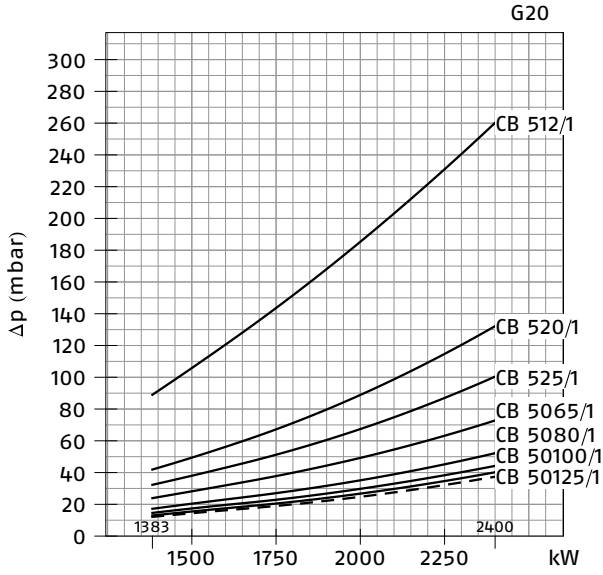

RS 200/M (NATURAL GAS)

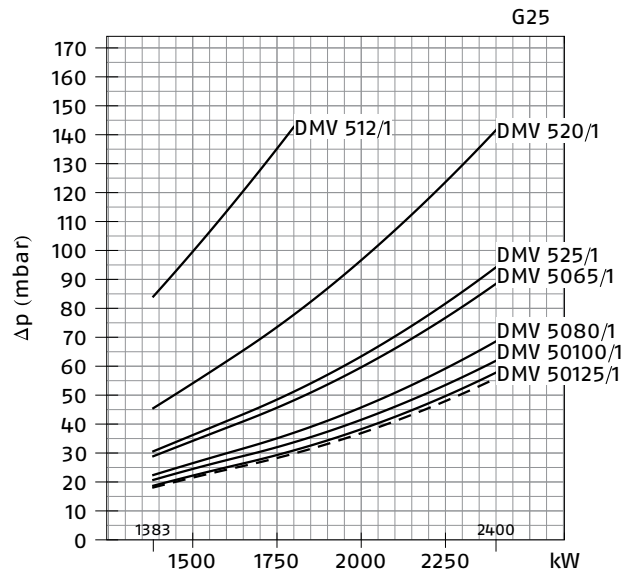
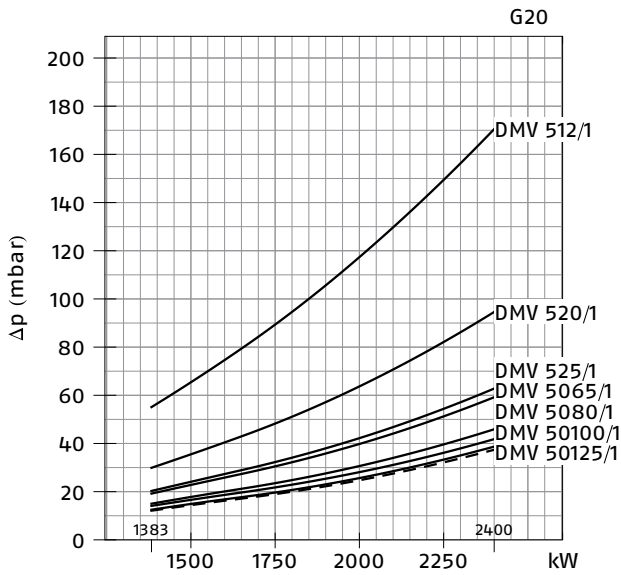

— Combustion head + gas butterfly valve + gas train
 - - - Combustion head + gas butterfly valve

GAS TRAIN			VPS	ADAPTER			
CODE	MODEL	C.T.	CODE	CODE			
				RS 25/M	RS 35-45/M	RS 55/M	
3970500	MB 405/1 - RT 20	-	3010123			●	
3970553	MB 407/1 - RT 20	-	3010123			3000824 + 3000843	
3970599	MB 407/1 - RT 52	-	3010123				
3970229	MB 407/1 - RSM 20	-	3010123				
3970258	MB 410/1 - RT 52	-	3010123		3010124	3010126	
3970554	MB 410/1 - RT 20	-	3010123			3000824 + 3000843	
3970600	MB 410/1 - RT 52	-	3010123				
3970230	MB 410/1 - RSM 20	-	3010123				
3970256	MB 412/1 - RT 52	-	3010123	-	-		
3970144	MB 412/1 - RT 20	-	3010123	-	-	3000843	
3970197	MB 412/1 CT RT 20	◆	-	-	-		
3970231	MB 412/1 - RSM 20	-	3010123	-	-		
3970180	MB 415/1 - RT 30	-	3010123	-	-		
3970198	MB 415/1 CT RT 30	◆	-	-	-		
3970250	MB 415/1 - RT 52	-	3010123	-	-		
3970253	MB 415/1 CT RT 52	◆	-	-	-		
3970232	MB 415/1 - RSM 30	-	3010123	-	-		
3970181	MB 420/1 - RT 30	-	3010123				-
3970182	MB 420/1 CT RT 30	◆	-				-
3970257	MB 420/1 - RT 52	-	3010123			-	
3970252	MB 420/1 CT RT 52	◆	-			-	
3970233	MB 420/1 - RSM 30	-	3010123			-	
3970234	MB 420/1 CT RSM 30	◆	-			-	
3970221	MBC 1200/1 - RSM 60	-	3010367			-	
3970225	MBC 1200/1 CT RSM 60	◆	-			-	
3970222	MBC 1900/1 - FSM 40	-	3010367	●	●	3000825	
3970226	MBC 1900/1 CT FSM 40	◆	-	●	●		
3970145	CB 512/1 - RSM 30	-	3010367	-	-	3000843	
20045589	CB 512/1 CT RSM 30	◆	-	-	-		
3970146	CB 520/1 - RSM 30	-	3010367			-	
3970160	CB 520/1 CT RSM 30	◆	-			-	
20044659	CB 525/1 - RSM 30	-	3010367			-	
20044660	CB 525/1 CT RSM 30	◆	-			-	
3970147	CB 5065/1 - FSM 30	-	3010367	●	●	3000825	
3970161	CB 5065/1 CT FSM 30	◆	-	●	●		
20043035	DMV 512/1 - RSM -0	-	3010367	-	-	3000843	
20043036	DMV 512/1 CT RSM -0	◆	-	-	-		
20043038	DMV 520/1 - RSM -0	-	3010367			-	
20043039	DMV 520/1 CT RSM -0	◆	-			-	
20043053	DMV 525/1 - RSM -0	-	3010367	●		-	
20043054	DMV 525/1 CT RSM -0	◆	-	●	3000822	-	
20043041	DMV 5065/1 - FSM -0	-	3010367	●		3000825	
20043042	DMV 5065/1 CT FSM -0	◆	-	●			
20043044	DMV 5080/1 - FSM -0	-	3010367	●	●	3000826	
20043045	DMV 5080/1 CT FSM -0	◆	-	●	●		

Key to layout
C.T. Gas valve leak detection control device:

- gas train not equipped with leak detection control device; this device can be ordered separately - see VPS column - and installed later.
- ◆ gas train equipped with leak detection control device.

VPS Valve leak detection control device. Supplied separately from the gas train, on demand.

● Not available

The valve seal control device is compulsory (conforming to EN 676) on gas trains to burners with a maximum output over 1200 kW.

GAS TRAIN			VPS	ADAPTER			
CODE	MODEL	C.T.	CODE	CODE			
				RS 68/M	RS 120/M	RS 160/M	RS 200/M
3970554	MB 410/1 - RT 20	-	3010123	3000824 + 3000843		●	●
3970600	MB 410/1 - RT 52	-	3010123			●	●
3970230	MB 410/1 - RSM 20	-	3010123			●	●
3970258	MB 410/1 - RT 52	-	3010123	3010126		●	●
20053263	MB 410/1 - CT RSM 20	◆	-	3000824 + 3000843		●	●
20057689	MB 410/1 - CT RSM 20	◆	-			●	●
3970144	MB 412/1 - RT 20	-	3010123	3010126			●
3970197	MB 412/1 CT RT 20	◆	-				●
3970231	MB 412/1 - RSM 20	-	3010123				●
3970256	MB 412/1 - RT 52	-	3010123				●
20052729	MB 412/1 - CT RSM 20	◆	-				●
20057687	MB 412/1 - CT RSM 20	◆	-				●
3970180	MB 415/1 - RT 30	-	3010123	3000843 (*)			
3970198	MB 415/1 CT RT 30	◆	-				
3970250	MB 415/1 - RT 52	-	3010123				
3970253	MB 415/1 CT RT 52	◆	-				
3970232	MB 415/1 - RSM 30	-	3010123				
20053268	MB 415/1 - CT RSM 30	◆	-				
20057563	MB 415/1 - CT RSM 30	◆	-				
3970181	MB 420/1 - RT 30	-	3010123	-	-	-	-
3970182	MB 420/1 CT RT 30	◆	-	-	-	-	-
3970257	MB 420/1 - RT 52	-	3010123	-	-	-	-
3970252	MB 420/1 CT RT 52	◆	-	-	-	-	-
3970233	MB 420/1 - RSM 30	-	3010123	-	-	-	-
3970234	MB 420/1 CT RSM 30	◆	-	-	-	-	-
20056541	MB 420/1 - CT RSM 30	◆	-	-	-	-	-
3970221	MBC 1200/1 - RSM 60	-	3010367	-	-	-	-
3970225	MBC 1200/1 CT RSM 60	◆	-	-	-	-	-
3970222	MBC 1900/1 - FSM 40	-	3010367	3000825			
3970226	MBC 1900/1 CT FSM 40	◆	-	3000825			
3970223	MBC 3100/1 - FSM 40	-	3010367	3000826			
3970227	MBC 3100/1 CT FSM 40	◆	-	3000826			
3970224	MBC 5000/1 - FSM 80	-	3010367	●	●	●	3010370 +
3970228	MBC 5000/1 CT FSM 80	◆	-	●	●	●	3000826
3970145	CB 512/1 - RSM 30	-	3010367	3000843			
20045589	CB 512/1 CT RSM 30	◆	-	3000843			
3970146	CB 520/1 - RSM 30	-	3010367	-	-	-	-
3970160	CB 520/1 CT RSM 30	◆	-	-	-	-	-
20044659	CB 525/1 - RSM 30	-	3010367	-	-	-	-
20044660	CB 525/1 CT RSM 30	◆	-	-	-	-	-
3970147	CB 5065/1 - FSM 30	-	3010367	3000825			
3970161	CB 5065/1 CT FSM 30	◆	-	3000825			
3970148	CB 5080/1 - FSM 30	-	3010367	3000826			
3970162	CB 5080/1 CT FSM 30	◆	-	3000826			
3970149	CB 50100/1 - FSM 30	-	3010367	3010370 + 3000826			
3970163	CB 50100/1 CT FSM 30	◆	-	3010370 + 3000826			
20015871	CB 50125/1 - FSM 30	-	3010367	●	3010224 + 3000826		
3970196	CB 50125/1 CT FSM 30	◆	-	●	3010224 + 3000826		

GAS TRAIN			VPS	ADAPTER			
CODE	MODEL	C.T.	CODE	CODE			
				RS 68/M	RS 120/M	RS 160/M	RS 200/M
20043035	DMV 512/1 - RSM -0	-	3010367	3000843			
20043036	DMV 512/1 CT RSM -0	◆	-	3000843			
20043038	DMV 520/1 - RSM -0	-	3010367	-	-	-	-
20043039	DMV 520/1 CT RSM -0	◆	-	-	-	-	-
20043053	DMV 525/1 - RSM -0	-	3010367	-	-	-	-
20043054	DMV 525/1 CT RSM -0	◆	-	-	-	-	-
20043041	DMV 5065/1 - FSM -0	-	3010367	3000825			
20043042	DMV 5065/1 CT FSM -0	◆	-	3000825			
20043044	DMV 5080/1 - FSM -0	-	3010367	3000826			
20043045	DMV 5080/1 CT FSM -0	◆	-	3000826			
20043047	DMV 50100/1 - FSM -0	-	3010367	3010370 + 3000826			
20043048	DMV 50100/1 CT FSM -0	◆	-	3010370 + 3000826			
20043050	DMV 50125/1 - FSM -0	-	3010367	●	●	3010224 + 3000826	
20043051	DMV 50125/1 CT FSM -0	◆	-	●	●	3010224 + 3000826	

Key to layout
C.T. Gas valve leak detection control device:

- gas train not equipped with leak detection control device; this device can be ordered separately - see VPS column - and installed later.
- ◆ gas train equipped with leak detection control device.

VPS Valve leak detection control device. Supplied separately from the gas train, on demand.

- Not available

The valve seal control device is compulsory (conforming to EN 676) on gas trains to burners with a maximum output over 1200 kW.

Selecting the Fuel Supply lines

The following diagram enables pressure drop in a pre-existing gas line to be calculated and to select the correct gas train.

The diagram can also be used to select a new gas line when fuel output and pipe length are known. The pipe diameter is selected on the basis of the desired pressure drop. The diagram uses methane gas as reference; if another gas is used, conversion coefficient and a simple formula (on the diagram) transform the gas output to a methane equivalent (refer to figure A). Please note that the gas train dimensions must take into account the back pressure of the combustion chamber during operations.

Control of the pressure drop in an existing gas line or selecting a new gas supply line.

The methane output equivalent is determined by the formula fig. A on the diagram and the conversion coefficient.

Once the equivalent output has been determined on the delivery scale (\dot{V}), shown at the top of the diagram, move vertically downwards until you cross the line that represents the pipe diameter; at this point, move horizontally to the left until you meet the line that represents the pipe length.

Once this point is established you can verify, by moving vertically downwards, the pipe pressure drop of on the bottom scale below (mbar).

By subtracting this value from the pressure measured on the gas meter, the correct pressure value will be found for the choice of gas train.

- Example:
- gas used G25
 - gas output 9.51 mc/h
 - pressure at the gas meter 20 mbar
 - gas line length 15 m
 - conversion coefficient 0.62 (see figure A)

- equivalent methane output $\dot{V} = \left[\frac{9.51}{0.62} \right] = 15.34 \text{ mc/h}$

- once the value of 15.34 has been identified on the output scale (\dot{V}), moving vertically downwards you cross the line that represents 1" 1/4 (the chosen diameter for the piping);
- from this point, move horizontally to the left until you meet the line that represents the length of 15 m of the piping;
- move vertically downwards to determine a value of 1.4 mbar in the pressure drop bottom scale;
- subtract the determined pressure drop from the meter pressure, the correct pressure level will be found for the choice of gas train;
- correct pressure = (20-1.4) = 18.6 mbar

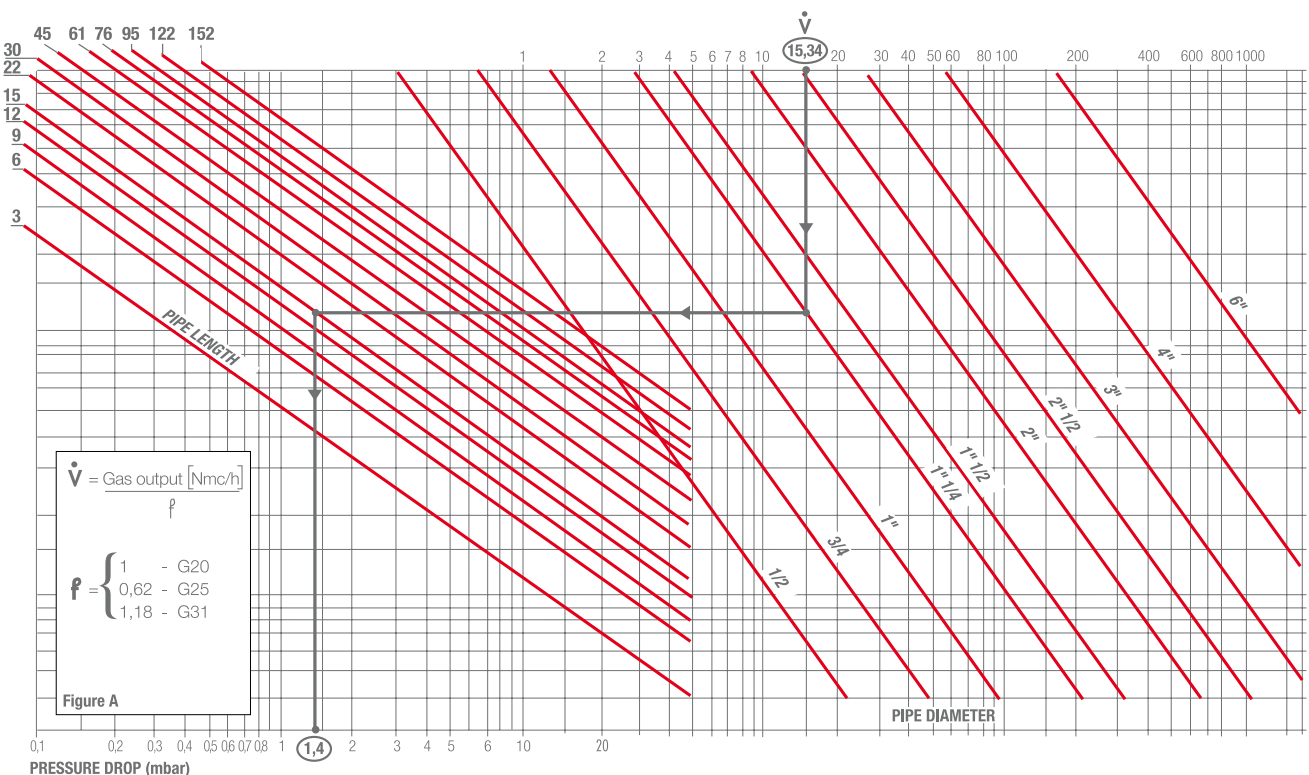

Ventilation

The ventilation circuit produces low noise levels with high performance pressure and air output, in despite of the compact dimensions.

On RS 45 - 55 - 68 - 120/M BLU models, the use of reverse curve blades and sound-proofing material keeps noise level very low.

In the RS 25 - 35 - 160 - 200/M BLU models, noise has been reduced by the special design of the air suction circuit.

A variable profile cam connects the fuel and air regulations, ensuring high fuel efficiency at all firing ranges.

A minimum air pressure switch stops the burner when there is an insufficient quantity of air at the combustion head.

Models with a special control panel and servomotor are suitable for steam generators which conform to TRD 604 (Germany) and NBN (Belgium).

The RS 25/M BLU and RS 35/M BLU are realised with a new structure made by an innovative technology based on a new fibreglass reinforced polyamide material, with high thermal and mechanical characteristics, instead of the traditional aluminium.

This allows big advantages in terms of lay-out rationalisation, weight and dimensions reduction.

In order to guarantee the correct exercise temperature for the internal burner components in every working conditions, the new structure includes an innovative patented cooling technology.

Between the burner front base and the reinforcing steel front plate, had been create an air cavity offering an high thermal insulation against the front boiler reflection heat, and to further improve the insulation efficiency the innovative HCS (**Housing Cooling System**) technology had been developed. Inside the front base cavity an air circulation is activated with continuous air volume refresh to obtain an active cooling system and avoid any heat transfer to the electrical component housing.



Example of the servomotor for air/gas setting.



Example of HCS (Housing Cooling System) working concept.

Combustion Head

Different lengths of the combustion head can be chosen for the RS/M BLU series of burners.

The choice depends on the thickness of the front panel and the type of boiler.

Depending on the type of generator, check that the penetration of the head into the combustion chamber is correct.

The internal positioning of the combustion head can easily be adjusted to the maximum defined output by adjusting a screw fixed to the flange.



Example of a RS 45/M BLU burner combustion head.



Example of a RS 160/M BLU burner combustion head.

SUGGESTED COMBUSTION CHAMBER DIMENSIONS

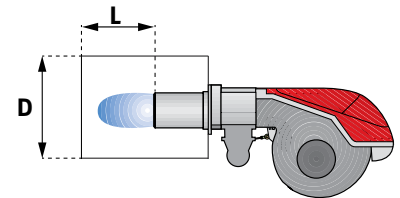
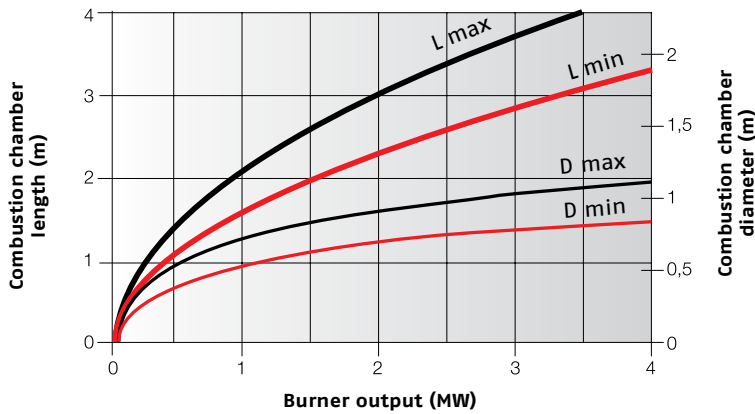

Example:
 Burner thermal output = 2000 kW;
 L Combustion Chamber (m) = 2,7 m (medium value);
 D Combustion Chamber (m) = 0,8 m (medium value)

Operation

BURNER OPERATION MODE

The RS/M BLU series of burners can have "two stage progressive" or "modulating" operation.

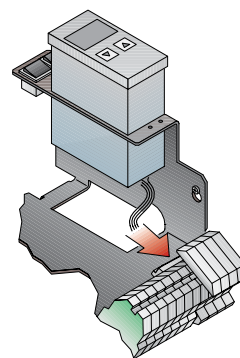

Example of a regulator.

On "two stage progressive" operation, the burner gradually adapts the output to the requested level, by varying between two pre-set levels (see picture A).

In "modulating" operation, normally required in steam generators, in superheated boilers or diathermic oil burners, a specific regulator or an analog control signal converter are required. These are supplied as accessories that must be ordered separately. The burner can work for long periods at intermediate output levels (see picture B).

"TWO STAGE PROGRESSIVE" OPERATION

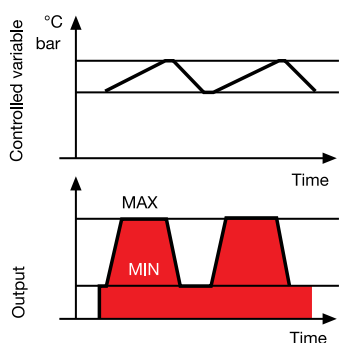

Picture A

"MODULATING" OPERATION

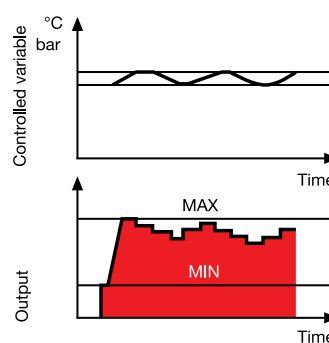

Picture B

All RS/M BLU series burners are fitted with a new microprocessor control panel for the supervision during intermittent operation.

For helping the commissioning and maintenance work, there are two main elements:

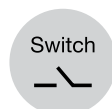

The lock-out reset button is the central **operating element** for resetting the burner control and for activating / deactivating the diagnostic functions.

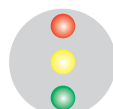

The multi-color LED is the central **indication element** for visual diagnosis and interface diagnosis.

Both elements are located under the transparent cover of lock-out reset button, as showed below.



There are two diagnostic choices, for indication of operation and diagnosis of fault cause:

VISUAL DIAGNOSIS



INTERFACE DIAGNOSIS

By the interface adapter and a PC with dedicated software or by a predisposed flue gas analyzer (see paragraph accessories).

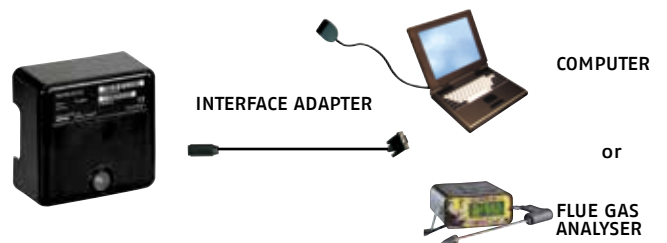

INDICATION OF OPERATION

In normal operation, the various status are indicated in the form of colour codes according to the table below. The interface diagnosis (with adapter) can be activated by pressing the lock-out button for > 3 seconds.

COLOR CODE TABLE	
OPERATION STATUS	COLOR CODE TABLE
Stand-by	● ● ● ● ● ● ● ●
Pre-purging	● ● ● ● ● ● ● ●
Ignition phase	● ● ● ● ● ● ● ●
Flame OK	● ● ● ● ● ● ● ●
Poor flame	● ● ● ● ● ● ● ●
Undervoltage, built-in fuse	● ● ● ● ● ● ● ●
Fault, alarm	● ● ● ● ● ● ● ●
Flame simulation	● ● ● ● ● ● ● ●

● LED off

DIAGNOSIS OF FAULT CAUSES

After lock-out has occurred, the red signal lamp is steady on. In this status, the visual fault diagnosis according to the error code table can be activated by pressing the lock-out reset button for > 3 seconds. The interface diagnosis (with adapter) can be activated by pressing again the lock-out button for > 3 seconds.

The flashing of red LED are a signal with this sequence:

(e.g. signal with n° 3 flashes – faulty air pressure monitor)



ERROR CODE TABLE

POSSIBLE CAUSE OF FAULT		FLASH CODE
No establishment of flame at the end of safety time:	- faulty or soiled fuel valves - faulty or soiled flame detector - poor adjustment of burner, no fuel - faulty ignition equipment	● 2x flashes
Faulty air pressure monitor		● 3x flashes
Extraneous light or simulation of flame on burner start up		● 4x flashes
Flame presence during pre-purging		● 5x flashes
Loss of flame during operation:	- faulty or soiled fuel valves - faulty or soiled flame detector - poor adjustment of burner	● 7x flashes
Minimum air pressure switch opens during operation		● 18x flashes
Wrong electrical connections		● 19x flashes
Faulty control box		● 20x flashes

Burner Wiring

All models of the RS/M BLU burner series have an easily accessible control panel for the electrical components housing and wiring.

In particular the new RS 25 - 35/M BLU models, thanks to the new structure concept, have a extremely clean electrical layout to optimise the commissioning and maintenance speed.

On these models the electrical connection are done by a Plug&Socket system, accessible from the external of the cover, and some of the main components as the servomotor, the air pressure switch, the electronic regulator (accessory) and the gas max pressure switch (accessory) are connected to the burner electrical wiring trough plugs & sockets system in order to facilitate the connection in case of maintenance.

The electrical wiring of all RS/M BLU burner models are very easy to do following the wiring diagrams included in the instruction handbook. Electrical connections must be made by qualified and skilled personnel, according to the local norms.

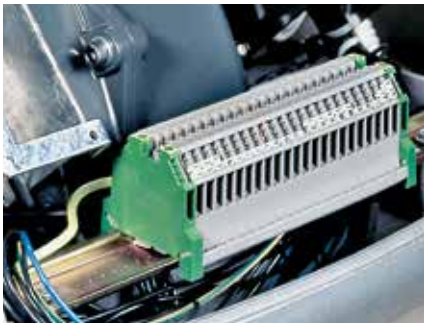

Example of the terminal board for electrical connections for the RS 68-120-160-200/M BLU models.



Example of electrical components housing and Plug&Socket system for electrical connection of RS 25-35/M BLU.



Emissions

NO2 EMISSIONS (gas G20)

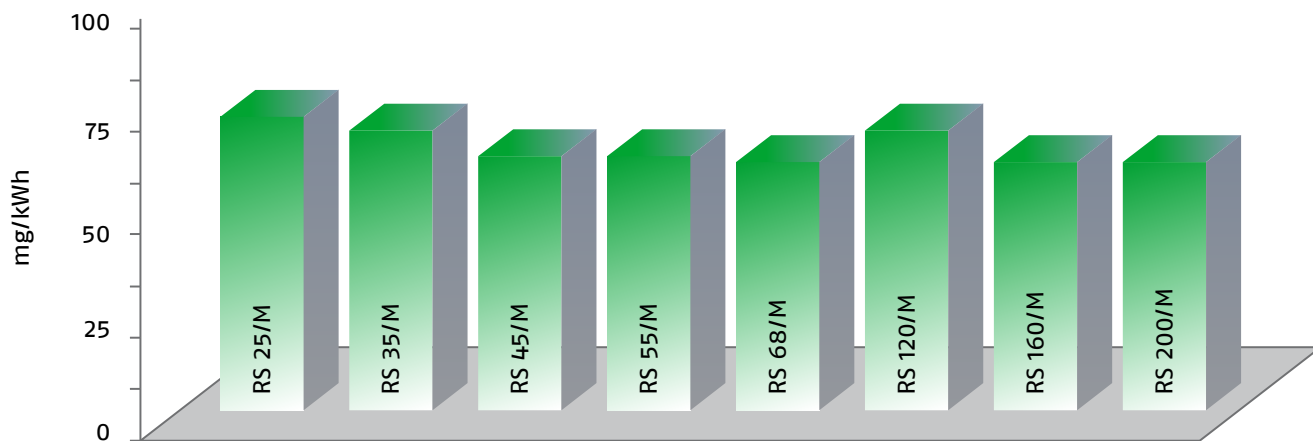

CO EMISSIONS (gas G20)

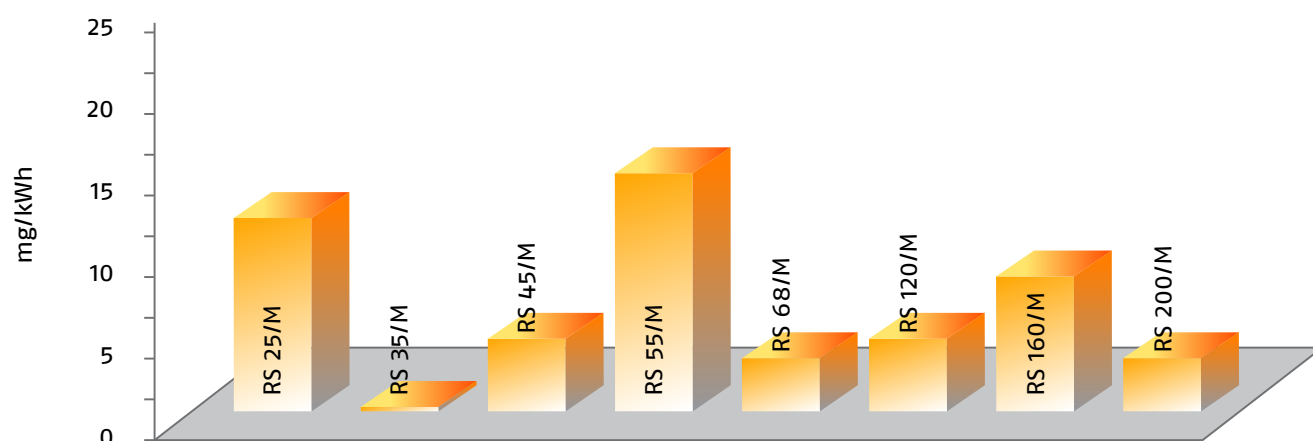

NOISE EMISSIONS

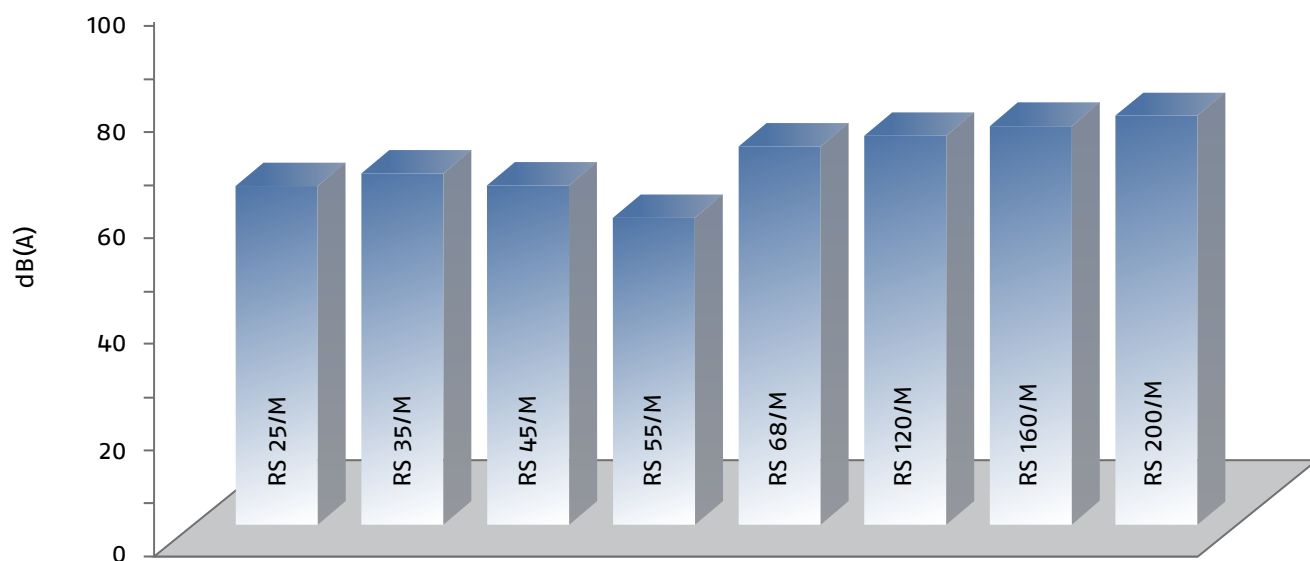

The noise emissions have been measured at the maximum output.

The RS/M BLU series combustion heads reduce polluting emissions thanks to their special design which optimises the air fuel mix.

The RS 25/M - 35/M - 45/M - 55M BLU models have an oblique radial pipe distributor through which gas is injected directly into the passing air flow for a perfect distribution.

This prevents no homogeneous concentrations in the flame with areas of high oxidation; part of the premixed gas/air is injected into the centre of the flame. These methods produce a very stable flame with gradual and progressive combustion as the flame develops, thus giving polluting emission values below even the most restrictive norm values.

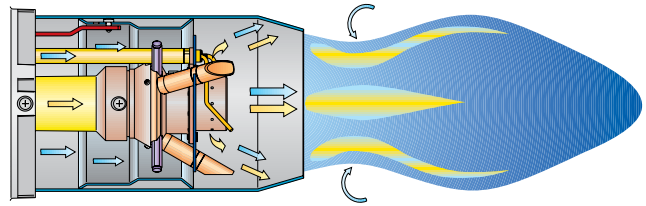

Combustion head operating diagram of RS 25/M - 35/M BLU models

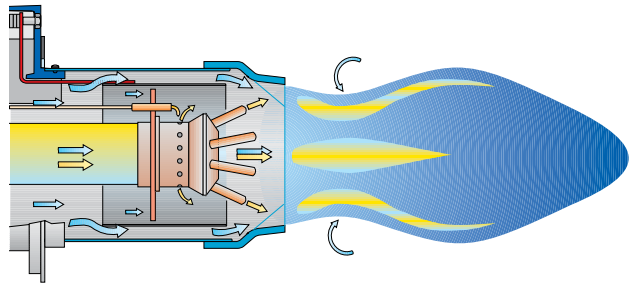

Combustion head operating diagram of RS 45/M - 55/M BLU models

In RS 68/M - 120/M - 160/M - 200/M BLU models part of the gas is distributed through outlets which are perpendicular to the air flow, while the remaining gas is injected directly into the centre of the flame.

This prevents no homogeneous concentrations in the flame with areas of high oxidation, producing very stable flame with gradual and progressive combustion as the flame develops, thus giving polluting emission values below even the most restrictive norm values.

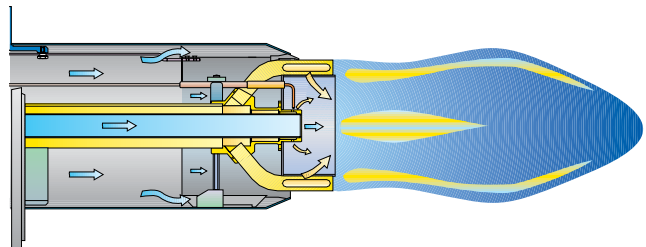

Combustion head operating diagram of RS 68/M - 120/M - 160/M - 200/M BLU models

Overall dimensions (mm)

BURNER

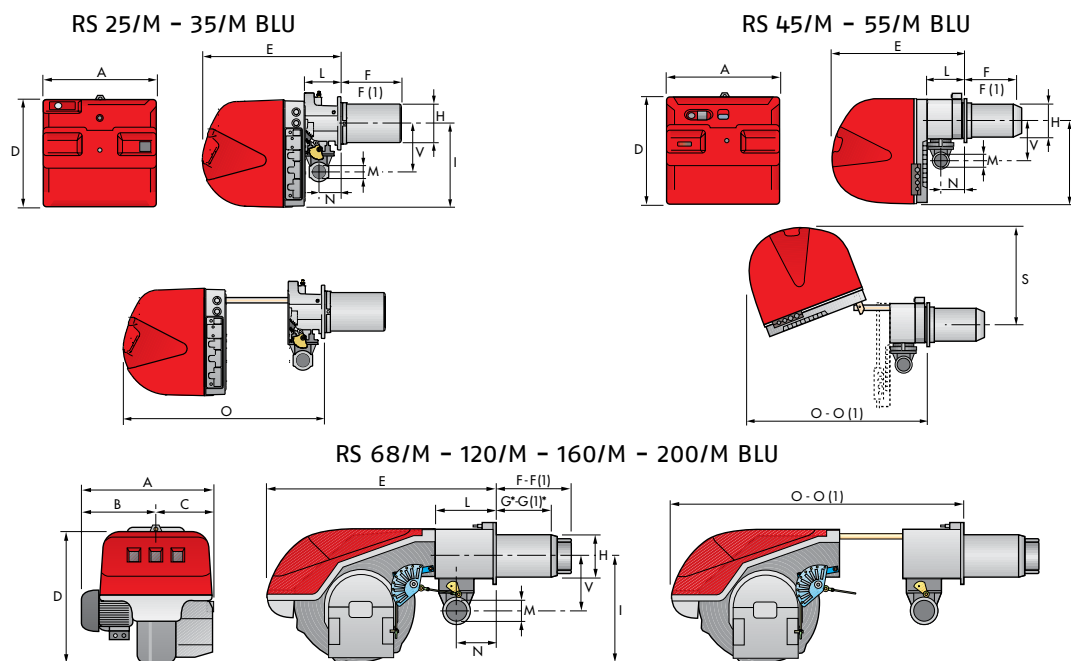

MODEL	A	B	C	D	E	F - F ⁽¹⁾	G* - G ^{(1)*}	H	I	L	M	N	O - O ⁽¹⁾	S	V
RS 25/M BLU	442	-	-	422	508	230 - 365	- - -	140	305	138	1"1/2	84	780 - -	-	177
RS 35/M BLU	442	-	-	422	508	230 - 365	- - -	152	305	138	1"1/2	84	780 - -	-	177
RS 45/M BLU	476	-	-	474	580	229 - 354	- - -	160	352	164	1"1/2	108	810 - 810	367	168
RS 55/M BLU	533	300	-	490	640	255 - 390	- - -	189	352	222	2"	134	870 - -	-	221
RS 68/M BLU	527	312	215	555	840	255 - 390	200 - 335	189	430	214	2"	134	1161 - 1296	-	221
RS 120/M BLU	553	338	215	555	840	255 - 390	200 - 335	189	430	214	2"	134	1161 - 1296	-	221
RS 160/M BLU	671	366	305	555	863	373 - 503	272 - 402	221	436	237	2"	141	1442 - 1587	-	264
RS 200/M BLU	737	432	305	555	863	373 - 503	272 - 402	221	436	237	2"	141	1442 - 1587	-	264

(1) Length with extended combustion head.

* Maximum depth of the boiler door including the depth of the burner flange insulating gasket.

BURNER - BOILER MOUNTING FLANGE

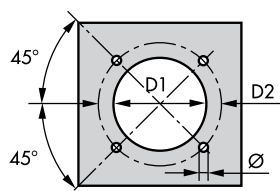

MODEL	D1	D2	Ø
RS 25/M BLU	160	224	M8
RS 35/M BLU	160	224	M8
RS 45/M BLU	165	224	M8
RS 55/M BLU	185	275-325	M12
RS 68/M BLU	195	275-325	M12
RS 120/M BLU	195	275-325	M12
RS 160/M BLU	230	325-368	M16
RS 200/M BLU	230	325-368	M16

PACKAGING

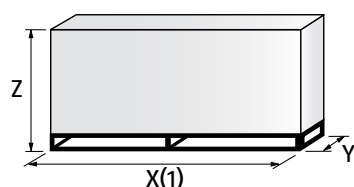

MODEL	X ⁽¹⁾	Y	Z	kg
RS 25/M BLU	1000	485	500	39
RS 35/M BLU	1000	485	500	40
RS 45/M BLU	1015	500	630	48
RS 55/M BLU	1405	700	660	44
RS 68/M BLU	1405	700	660	78
RS 120/M BLU	1405	700	660	84
RS 160/M BLU	1405-1420	1000	660	89
RS 200/M BLU	1405-1420	1000	660	125

(1) dimension with standard and extended head

Installation Description

Installation, start up and maintenance must be carried out by qualified and skilled personnel. All operations must be performed in accordance with the technical handbook supplied with the burner.

BURNER SETTING

All the burners have slide bars, for easier installation and maintenance.

After drilling the boilerplate, using the supplied gasket as a template, dismantle the blast tube from the burner and fix it to the boiler.

Adjust the combustion head.

Fit the gas train, choosing this on the basis of the maximum output of the boiler and considering the enclosed diagrams.

Refit the burner casing to the slide bars.

Close the burner, sliding it up to the flange.



ELECTRICAL CONNECTIONS AND START UP

Make the electrical connections to the boiler following the wiring diagrams included in the instruction handbook.

Turn the motor to check rotation direction (if it is a three-phase motor).

Perform a first ignition calibration on the gas train.

On start up, check:

- Gas pressure at the combustion head (to max. and min. output)
- Combustion quality, in terms of unburned substances and excess air.



BURNER MAINTENANCE

The maintenance of RS/M BLU burners is very simple thanks to the sliding bars system that allows an easy access to the internal components.

In particular the RS 25-35/M BLU models have a new sliding bars system to make easier the access to the combustion head.

The RS 160-200/M BLU have new reinforced sliding bars that make very strong the burner structure during maintenance.

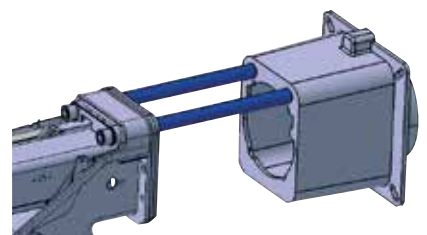

Burner accessories

Extended head kit

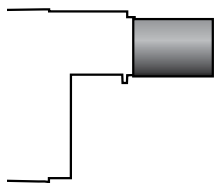

“Standard head” burners can be transformed into “extended head” versions, by using the special kit. The KITS available for the various burners, giving the original and the extended lengths, are listed below.

BURNER	STANDARD HEAD LENGTH (mm)	EXTENDED HEAD LENGTH (mm)	KIT CODE
RS 25/M BLU	230	365	3010430
RS 35/M BLU	230	365	3010431
RS 45/M BLU	229	354	3010240
RS 55/M BLU	255	390	20040373
RS 68/M - 120/M BLU	255	390	3010177
RS 160/M BLU	373	503	3010442 *
RS 200/M BLU	373	503	3010474

* Kit to be used on burners recognizable by a serial number that is over or equal to 02426XXXXXX, for burners with a serial number that is under or equal to 02416XXXXXX please use the Kit coded 3010193

Spacer kit



If burner head penetration into the combustion chamber needs reducing, varying thickness spacers are available, as given in the following list.

BURNER	SPACER THICKNESS S (mm)	KIT CODE
RS 25/M - 35/M - 45/M BLU	110	3010095
RS 55/M - 68/M - 120/M BLU	135	3010129
RS 160/M - 200/M BLU	102	3000722

Continuous ventilation kit



If the burner requires continuous ventilation in the stages without flame, a special kit is available as given in the following table.

BURNER	KIT CODE
RS 25/M - 35/M BLU	3010449
RS 45/M - 55/M - 68/M - 120/M - 160/M - 200/M BLU	3010094

Sound proofing box

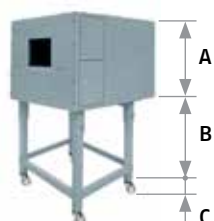

If noise emission needs reducing even further, sound-proofing boxes are available.

In case of generator heights, where a lower dimension “B” is required, ask for the Box Support Kit code 20065135.

BURNER	BOX TYPE	A (mm)	B (mm) MIN-MAX	C (mm)	[dB(A)] (*)	BOX CODE
RS 25/M - 35/M - 45/M - 55/M BLU	C1/3	650	372 - 980	110	10	3010403
RS 68/M - 120/M - 160/M - 200/M BLU	C4/5	850	160 - 980	110	10	3010404

(*) Average noise reduction according to EN 15036-1 standard

Accessories for modulating operation



To obtain modulating operation, the RS/M BLU series of burners requires a regulator with three point outlet controls. On RS 25/M - 35/M BLU the regulator is connected to the burner electrical wiring by plug-in system in order to make the connection easier and faster.

The following table lists the accessories for modulating operation with their application range.

BURNER	REGULATOR TYPE	REGULATOR CODE
RS 25/M - 35/M - 45/M BLU	RWF 50.2	20083339
	RWF 55.5	20098541
RS 55/M BLU	RWF 50.2	20101190
	RWF 55.5	20101191
RS 68/M - 120/M BLU	RWF 50.2	20082208
	RWF 55.5	20099657
RS 160/M - 200/M BLU	RWF 50.2	20099869
	RWF 55.5	20099905



The relative temperature or pressure probes fitted to the regulator, must be chosen on the basis of the application.

BURNER	PROBE TYPE	RANGE (°C) (bar)	PROBE CODE
All models	Temperature PT 100	-100 ÷ 500°C	3010110
	Pressure 4 ÷ 20 mA	0 ÷ 2,5 bar	3010213
	Pressure 4 ÷ 20 mA	0 ÷ 16 bar	3010214
	Pressure 4 ÷ 20 mA	0 ÷ 25 bar	3090873



Modulating operation can also be obtained with an analog control signal converter and a feedback three-pole potentiometer.

Alternatively, the potentiometer can be used to check the servomotor position.

BURNER	TYPE (INPUT SIGNAL)	CODE
RS 25/M - 35/M BLU	0/2 - 10 V (impedance 200 KΩ)	3010410
	0/4 - 20 mA (impedance 250 Ω)	
RS 45/M BLU - 55/M	0/2 - 10 V (impedance 200 KΩ)	3010390
	0/4 - 20 mA (impedance 250 Ω)	
RS 68/M - 120/M - 160/M - 200/M BLU	0/2 - 10 V (impedance 200 KΩ)	3010415
	0/4 - 20 mA (impedance 250 Ω)	



Depending on the servomotor fitted to the burner, a three-pole potentiometer (1000 W) can be installed to check the position of the servomotor. The KITS available for the various burners are listed below.

BURNER	POTENTIOMETER KIT CODE
RS 25/M - 35/M BLU	3010420
RS 45/M - 55/M BLU	3010109
RS 68/M - 120/M - 160/M - 200/M BLU	3010416

Head kit for "reverse flame chamber"



In certain cases, the use of the burner on reverse flame boilers can be improved by using an additional Pipes Kit.

BURNER	KIT CODE
RS 68/M BLU	3010247
RS 120/M BLU	3010248
RS 160/M BLU	3010249
RS 200/M BLU	20035848

Ground fault interrupter kit



A "Ground fault interrupter kit" is available as a safety device in case of electrical system fault.

BURNER	KIT CODE
RS 25/M - 35/M BLU	3010448
RS 45/M - 55/M - 68/M - 120/M - 160/M - 200/M BLU	3010329

Gas max pressure switch

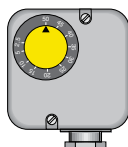

If necessary a Gas max pressure Switch kit is available and connectable to the burner electrical wiring trough Plugs & Sockets system.

BURNER	CODE
RS 25/M - 35/M BLU	3010418

Volt free contact kit



A volt free contact kit is available for installation onto the burner. It can be used for a remote interface between burner operating signals. Every burner can be equipped with a single kit for a remote check of the flame presence signal and the burner lockout indication.

BURNER	KIT CODE
RS 25/M - 35/M - 55/M BLU	3010419

PC Interface kit



To connect the control box to a personal computer for the transmission of operation, fault signals and detailed service information, an interface adapter with PC software are available.

BURNER	KIT CODE
All models	3002719

DN80 gas flange kit

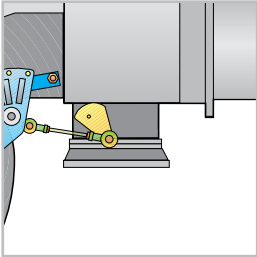

To modify the standard 2" burner gas input connection in to DN80 connection, a specific gas flange is available.

BURNER	KIT CODE
RS 68/M - 120/M - 160/M - 200/M BLU	3010439

Post-ventilation kit

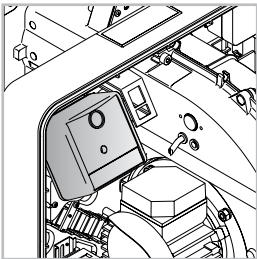

To have 20 s ventilation after opening of thermostats chain, a special kit is available.

BURNER	KIT CODE
RS 25/M - 35/M BLU	3010451

Hours counter kit

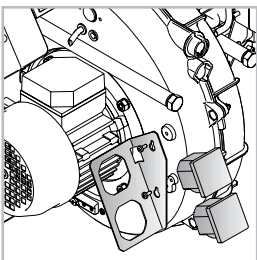

To measure the burner working time a hours counter kit is available.

BURNER	KIT CODE
RS 25/M - 35/M BLU	3010450

LPG kit

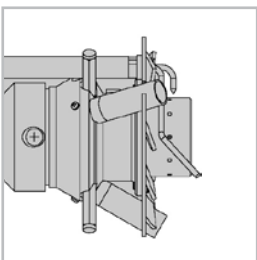

For burning LPG gas, a special kit is available to be fitted to the combustion head on the burner, as given in the following table.

BURNER	KIT CODE FOR STANDARD HEAD	KIT CODE FOR EXTENDED HEAD
RS 25/M BLU	3010423	3010423
RS 35/M BLU	3010424	3010424
RS 45/M BLU	3010432 *	3010432 *
RS 55/M BLU	in progress	in progress
RS 68/M BLU	3010433 *	3010433 *
RS 120/M BLU	on demand	on demand
RS 160/M BLU	20008971 *	20008971 *
RS 200/M BLU	3010491	3010491

(*) certification in progress, CE approval on field is required.

Protection kit (electromagnetic interferences)







When the burner is installed in a room particularly subject to electromagnetic interference (signals emitted over 10 V/m) due for example to INVERTER presence or in systems where the lengths of the thermostat connections is over 20 meters, this specific protection kit is available as an interface between the thermostatic controls and the burner.

BURNER	KIT CODE
All models	3010386

Gas train accessories

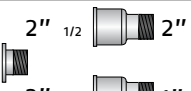
Adapters

When the diameter of the gas train is different from the set diameter of the burners, an adapter must be fitted between the gas train and the burner. Below are given the available adapters; please see on the Gas Train list the correct adapter codes to select.

ADAPTER	LENGTH mm	ADAPTER CODE
2"  1" 1/2	70	3000822
3/4"  1" 1/2	31	3000824
DN 65  2" 1/2	300	3000825
DN 80  2" 1/2	300	3000826
1" 1/2  2"	35	3000843
1" 1/4  1" 1/2	35	3010124
1" 1/4  2"	35	3010126

Seal control kit



To test the valve seals on the gas train, a special "seal control kit" is available. The valve seal control device is compulsory (EN 676) on gas trains to burners with a maximum output over 1200 kW. The seal control is type VPS 504.

GAS TRAIN	KIT CODE FOR 50 Hz OPERATION	KIT CODE FOR 60 Hz OPERATION
MB/1 type	3010123	20050030
MBC/1 type	3010367	20050030
CB/1 type	3010367	20050030
DMV/1 type	3010367	20050030

Stabiliser spring



To vary the pressure range of the gas train stabilisers, accessory springs are available. The following table shows these accessories with their application range. Please refer to the technical manual for the correct choice of spring.

GAS TRAIN	SPRING COLOUR	SPRING PRESSURE RANGE mbar	SPRING CODE
MBC 1900/1 - 3100/1 - 5000/1*	White	4 - 20	3010381
	Red	20 - 40	3010382
	Black	40 - 80	3010383
	Green	80 - 150	3010384
CB 512/1 DMV 512/1*	Red	25 - 55	3010131
	Black	60 - 110	3010157
	Pink	90 - 150	3090486
CB 520/1* - 525/1* DMV 520/1* - 525/1*	Red	25 - 55	3010132
	Black	60 - 110	3010158
	Pink	90 - 150	3090487
CB 5065/1* - 5080/1* DMV 5065/1* - 5080/1*	Red	25 - 55	3010133
	Black	60 - 110	3010135
	Pink	100 - 150	3090456
CB / DMV 50100/1*	Grey	140 - 200	3090992
	Red	25 - 55 mbar	3010134
	Black	60 - 110 mbar	3010136
	Pink	100 - 150 mbar	3090489
CB / DMV 50125/1*	Grey	140 - 200 mbar	3092174
	Red	25 - 55 mbar	3010315
	Yellow	30 - 70 mbar	3010316
	Black	60 - 110 mbar	3010317
	Pink	100 - 150 mbar	3010318

Specification

Designation of series

A specific index guides your choice of burner from the various models available in the RS/M series. Below is a clear and detailed specification description of the product.

Series: R											
Fuel:		S	Natural Gas								
		L	Light oil								
		LS	Light oil/Natural Gas								
		N	Heavy oil								
Size											
Setting :		/1	Single stage					/E	Electronic cam		
		/B	Two stage					/P	Proportioning air/gas valve		
		/M	Modulating - Mechanical cam					/EV	Electronic cam predisposed for variable speed (with inverter)		
Emission :		C11 or ...	Class 1 EN267 - EN676								
		C22 or MZ	Class 2 EN267 - EN676								
		C33 or BLU	Class 3 EN267 - EN676								
		C23 or MX	Class 2 EN267 - Class 3 EN676								
		C13	Class 1 EN267 - Class 3 EN676								
Head length:		TC	standard head								
		TL	extended head								
Flame control system:											
		FS1	Standard (1 stop every 24 h)								
		FS2	Continuous working (1 stop every 72 h)								
Electrical supply to the system:											
		1/230/50	1/230V/50Hz								
		3/230/50	3/230V/50Hz								
		3/400/50	3N/400V/50Hz								
		3/230-400/50	3/230V/50Hz - 3N/400V/50Hz								
		3/220/60	3/220V/60Hz								
		3/380/60	3N/380V/60Hz								
		3/220-380/60	3/220/60Hz - 3N/380V/60Hz								
Auxiliary voltage:											
		230/50-60	230V/50-60Hz								
		110/50-60	110V/50-60Hz								
R	S	120	/M	BLU	TC	FS1	3/230-400/50	230/50-60			
BASIC DESIGNATION											
EXTENDED DESIGNATION											

Available burner models

RS 25/M BLU	TC	FS1	1/220-230/50-60	220-230/50-60
RS 25/M BLU	TL	FS1	1/220-230/50-60	220-230/50-60
RS 35/M BLU	TC	FS1	1/220-230/50-60	220-230/50-60
RS 35/M BLU	TL	FS1	1/220-230/50-60	220-230/50-60
RS 35/M BLU	TC	FS1	3/220-400/50-60	220-230/50-60
RS 35/M BLU	TL	FS1	3/220-400/50-60	220-230/50-60
RS 25/M BLU	TC	FS2	1/220-230/50-60	220-230/50-60
RS 25/M BLU	TL	FS2	1/220-230/50-60	220-230/50-60
RS 35/M BLU	TC	FS2	1/220-230/50-60	220-230/50-60
RS 35/M BLU	TL	FS2	1/220-230/50-60	220-230/50-60
RS 35/M BLU	TC	FS2	3/220-400/50-60	220-230/50-60
RS 35/M BLU	TL	FS2	3/220-400/50-60	220-230/50-60
RS 45/M BLU	TC	FS1	1/230/50	230/50-60
RS 45/M BLU	TL	FS1	1/230/50	230/50-60
RS 45/M BLU	TC	FS2	1/230/50	230/50-60
RS 45/M BLU	TL	FS2	1/230/50	230/50-60
RS 55/M BLU	TC	FS1	3/230-400/50	230/50-60
RS 55/M BLU	TL	FS1	3/230-400/50	230/50-60
RS 68/M BLU	TC	FS1	3/230-400/50	230/50-60
RS 68/M BLU	TL	FS1	3/230-400/50	230/50-60
RS 68/M BLU	TC	FS2	3/230-400/50	230/50-60
RS 68/M BLU	TL	FS2	3/230-400/50	230/50-60
RS 68/M BLU	TC	FS1	3/230-400/50	230/50-60
RS 68/M BLU	TL	FS1	3/230-400/50	230/50-60
RS 120/M BLU	TC	FS1	3/230-400/50	230/50-60
RS 120/M BLU	TL	FS1	3/230-400/50	230/50-60
RS 120/M BLU	TC	FS2	3/230-400/50	230/50-60
RS 120/M BLU	TL	FS2	3/230-400/50	230/50-60
RS 120/M BLU	TC	FS1	3/230-400/50	230/50-60
RS 120/M BLU	TL	FS1	3/230-400/50	230/50-60
RS 120/M BLU	TL	FS1	3/220-380/60	230/50-60
RS 160/M BLU	TC	FS1	3/400/50	230/50-60
RS 160/M BLU	TC	FS1	3/230/50	230/50-60
RS 160/M BLU	TL	FS1	3/400/50	230/50-60
RS 160/M BLU	TL	FS1	3/230/50	230/50-60
RS 160/M BLU	TC	FS2	3/400/50	230/50-60
RS 160/M BLU	TC	FS2	3/230/50	230/50-60
RS 160/M BLU	TL	FS2	3/400/50	230/50-60
RS 160/M BLU	TL	FS2	3/230/50	230/50-60
RS 160/M BLU	TC	FS1	3/400/50	230/50-60
RS 160/M BLU	TC	FS1	3/230/50	230/50-60
RS 160/M BLU	TL	FS1	3/400/50	230/50-60
RS 160/M BLU	TL	FS1	3/380/60	230/50-60
RS 160/M BLU	TL	FS1	3/380/60	230/50-60
RS 200/M BLU	TC	FS1	3/400/50	230/50-60
RS 200/M BLU	TL	FS1	3/400/50	230/50-60
RS 200/M BLU	TC	FS1	3/230/50	230/50-60
RS 200/M BLU	TL	FS1	3/230/50	230/50-60
RS 200/M BLU	TC	FS2	3/400/50	230/50-60
RS 200/M BLU	TL	FS2	3/400/50	230/50-60
RS 200/M BLU	TC	FS2	3/230/50	230/50-60
RS 200/M BLU	TL	FS2	3/230/50	230/50-60

RS 45/M BLU	TC	FS1	1/230/50	230/50-60 ID
RS 45/M BLU	TL	FS1	1/230/50	230/50-60 ID
RS 45/M BLU	TC	FS2	1/230/50	230/50-60 ID
RS 45/M BLU	TL	FS2	1/230/50	230/50-60 ID

Product specification

Monoblock forced draught Low NOx gas burner, two stage progressive or modulating operation with a kit, made up of:

- Air suction circuit with sound proofing material
- Air damper for air flow setting and butterfly valve for regulating fuel output controlled by a servomotor with variable cam
- Low emissions combustion head, that can be set on the basis of required output, fitted with:
 - stainless steel end cone, resistant to corrosion and high temperatures
 - ignition electrodes
 - ionisation probe
 - gas distributor
 - flame stability disk
- Minimum air pressure switch stops the burner in case of insufficient air quantity at the combustion head
- Burner on/off selection switch
- Manual or automatic output increase/decrease switch
- Microprocessor-based burner safety control box, with diagnostic functions
- Flame inspection window
- Slide bars for easier installation and maintenance
- Protection filter against radio interference

RS 25-35/M BLU models

- High performance fan with forward curve blades
- Starting motor at 2800 rpm, single-phase / 220-230V / 50-60Hz or three-phase / 380-400V / 50-60Hz
- Exclusive patented HCS (Housing Cooling System) with high thermal insulation and air circulation with continuous air volume refresh for an active cooling system and avoid heat transfer to the electrical component housing
- Plug and socket for electrical connections accessible from the external of the cover
- IP 40 electric protection level.

RS 45-55-68-120-160-200/M BLU models

- Fan with reverse curve blades (RS 45-55-68-120/M BLU models) or forward curve blades (RS 160-200/M BLU models)
- Sound-proofing material on air suction circuit
- Starting motor at 2800 rpm, three-phase 400V with neutral, 50Hz (single-phase, 230V, 50Hz for the RS 45/M BLU model)
- Maximum gas pressure switch (on RS 55-68-120-160-200/M BLU models)
- IP 44 electric protection level.

Standard equipment

- 1 gas train flange
- 1 flange gasket
- 4 screws for fixing the flange
- 1 thermal screen
- 4 screws for fixing the burner flange to the boiler
- Fairleads for the electrical connection (RS 45/M BLU)
- 3 plugs for electrical connection (RS 25-35/M BLU single-phase)
- 4 plugs for electrical connection (RS 35/M BLU three-phase)
- 2 slide bar extensions (for extended head models and RS 160-200/M BLU models)
- Instruction handbook for installation, use and maintenance
- Spare parts catalogue.

Riello Burners a world of experience in every burner we sell.



[1]



[2]

Across the world, Riello sets the standard in reliable and high efficiency burner technology.

With burner capacity from 5 kW to 48 MW, Riello gas, oil, dual fuel and Low Nox burners deliver unbeatable performance across the full range of residential and commercial heating applications, as well as in industrial processes.

With headquarter in Legnago, Italy, Riello has been manufacturing premium quality burners for over 90 year. The manufacturing plant is equipped with the most innovative systems of assembling lines and modern manufacturing cells for a quick and flexible response to the market.

Besides, the Riello Combustion Research Centre, located in Angiari, Italy, represents one of the most modern facility in Europe and one of the most advanced in the world for the development of the combustion technology.

Today, the company's presence on worldwide markets is distinguished by a well-constructed and efficient sales network, alongside many important Training Centres located in various countries to meet its customers' needs. Riello has 13 operational branches abroad (in Europe, America and Asia), with customers in over 60 countries.

[1] BURNERS PRODUCTION PLANT
S. PIETRO, LEGNAGO (VERONA) - ITALIA

[2] HEADQUARTER BURNERS DIVISION
S. PIETRO, LEGNAGO (VERONA) - ITALIA

RIELLO S.p.A. - 37045 Legnago (VR) - Italy
tel. +39 0442 630111 - fax: +39 0442 21980
www.riello.com

Since the Company is constantly engaged in the production improvement, the aesthetic and dimensional features, the technical data, the equipment and the accessories can be changed. This document contains confidential and proprietary information of RIELLO S.p.A. Unless authorised, this information shall not be divulged, nor duplicated in whole or in part.

RIELLO