

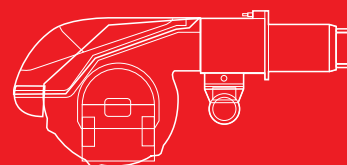

RS 25÷200/E-EV BLU Series

Low NOx Modulating Gas Burners

RS 25/E BLU	45/125	÷	370 kW
RS 35/E BLU	72/202	÷	480 kW
RS 45/E BLU	90/190	÷	550 kW
RS 55/E BLU	100/300	÷	680 kW
RS 68/E BLU-RS 68/EV BLU	150/350	÷	860 kW
RS 120/E BLU-RS 120/EV BLU	300/600	÷	1300 kW
RS 160/E BLU-RS 160/EV BLU	300/930	÷	1860 kW
RS 200/E BLU-RS 200/EV BLU	570/1375	÷	2400 kW

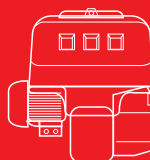

The RS/E - /EV BLU burners series covers a firing range from 125 to 2400 kW, and it is based on the Digital Burner Management System, Riello REC27-37, which is able to manage the air-fuel ratio by independent servomotors in order to obtain a perfect output control and to assure a correct combustion and safe operation on all modulation range.

Operation can be "two stage progressive" or, alternatively, "modulating" with the installation of a PID logic regulator and respective probes.

RS/E - /EV BLU burners series guarantees high efficiency levels in all the various applications, thus reducing fuel consumption and running costs.

The exclusive design ensures reduced dimensions, simple use and maintenance.

A wide range of accessories guarantees elevated working flexibility.

Technical Data

MODEL		RS 25/E BLU	RS 35/E BLU	RS 45/E BLU	RS 55/E BLU
Burner operation mode		Modulating (with regulator and probes accessories)			
Modulation ratio at max. output		4 ÷ 1		3 ÷ 1	4 ÷ 1
Servomotor	Type	SQN 13.14 (air and gas)			SQN90
	Run time	s			
Heat output	kW	76/125÷370	100/200÷480	90/190÷550	100/300÷680
	Mcal/h	65/108÷318	86/172÷413	77/164÷473	86/259÷586
Working temperature	°C min./max.	0/40			
FUEL/AIR DATA					
Net calorific value G20 gas	kWh/Nm ³	10			
Density gas G20	kg/Nm ³	0,71			
Output gas G20	Nm ³ /h	8/13÷37	10/20÷48	9/19÷55	10/30 ÷ 68
Net calorific value G25 gas	kWh/Nm ³	8,6			
Density gas G25	kg/Nm ³	0,78			
Output gas G25	Nm ³ /h	9/15÷43	12/23÷56	10.5/22÷64	11.7/35 ÷ 79
Net calorific value LPG gas	kWh/Nm ³	25,8			
Density LPG gas	kg/Nm ³	2,02			
Output LPG gas	Nm ³ /h	3/5÷14	4/8÷19	3.5/7.4 ÷ 21.3	3.9/11.7 ÷ 26.4
Fan	Type	(02)		(01)	
Air temperature	Max. °C	60			
ELECTRICAL DATA					
Electrical supply	Ph/Hz/V	(04)	(04)	(06)	(03)
Auxiliary electrical supply	Ph/Hz/V	(04)	(04)	(04)	(03)
Control box	Type	REC 27			
Total electrical power	kW	0,6	0,7	0,75	0,7
Auxiliary electrical power	kW	0,3	0,28	0,3	0,3
Protection level	IP	40		44	40
Motor electrical power	kW	0,3	0,42	0,45	0,42
Rated motor current	A	3,2	3,5	2 - 1,4	3
Motor start current	A	15	17	14 - 10	14
Motor protection level	IP	54			
Ignition transformer	V1 - V2	230V - 1x15 kV			220/240 - 1x15 kV
	I1 - I2	1A - 25 mA		45vA - 25 mA	1A - 25 mA
Operation		Intermittent (at least one stop every 24 h)			
EMISSIONS					
Sound pressure	dB(A)	70	72	70	64
Sound output	W	--			64
CO Emission	mg/kWh	< 20			
NOx Emission	mg/kWh	< 80			< 67
APPROVAL					
Directive		2009/142 - 2006/42 - 2006/95 - 2004/108 EC			
Conforming to		EN 676			
Certification		CE-0085BR0379	CE-0085 BM0104	CE 0085CM0293	

- (01) Centrifugal with reverse curve blades
(02) Centrifugal with forward curve blades
(03) 1/50/230~(±10%)
(04) 1/50-60/230~(±10%)
(05) 3N/50/230-400~(±10%)
(06) 3N/50-60/230-400~(±10%)
(07) 3N/50/400~(±10%)

Reference conditions:

Temperature: 20°C - Pressure: 1013,5 mbar - Altitude: 0 m a.s.l. - Noise measured at a distance of 1 meter.

Since the Company is constantly engaged in the production improvement, the aesthetic and dimensional features, the technical data, the equipment and the accessories can be changed. This document contains confidential and proprietary information of RIELLO S.p.A. Unless authorised, this information shall not be divulged, nor duplicated in whole or in part.

MODEL		RS 68/E-/EV BLU	RS 120/E-/EV BLU	RS 160/E-/EV BLU	RS 200/E-/EV BLU
Burner operation mode		Modulating (with regulator and probes accessories)			
Modulation ratio at max. output		3 ÷ 1		4 ÷ 1	
Servomotor	Type	SQM 33.5 (air) SQM 33.4 (gas)			
	Run time	s			
Heat output	kW	150/350÷860	300/600÷1300	300/930÷1860	570/1375÷2400
	Mcal/h	129/301÷740	258/516÷1118	258/800÷1600	490/1182÷2064
Working temperature	°C min./max.	0/40			
FUEL/AIR DATA					
Net calorific value G20 gas	kWh/Nm ³	10			
Density gas G20	kg/Nm ³	0,71			
Output gas G20	Nm ³ /h	15/35÷86	30/60÷130	30/93÷186	57/137÷240
Net calorific value G25 gas	kWh/Nm ³	8,6			
Density gas G25	kg/Nm ³	0,78			
Output gas G25	Nm ³ /h	17,5/41÷100	35/70÷151	35/108÷216	66/160÷279
Net calorific value LPG gas	kWh/Nm ³	25,8			
Density LPG gas	kg/Nm ³	2,02			
Output LPG gas	Nm ³ /h	3/5÷14		22/53-93	
Fan	Type	(01)		(02)	
Air temperature	Max. °C	60			
ELECTRICAL DATA					
Electrical supply	Ph/Hz/V	(05)	(05)	(05)	(05)
Auxiliary electrical supply	Ph/Hz/V	(03)	(03)	(03)	(03)
Control box	Type	REC 27 (/E models) - REC 37 (/EV models)			
Total electrical power	kW	2,0	2,8	5,3	6,5
Auxiliary electrical power	kW	0,5	0,6	0,8	0,8
Protection level	IP	44			
Motor electrical power	kW	1,5	2,2	4,5	5,5
Rated motor current	A	6,1 - 3,5	8,5 - 4,9	15,8 - 9,1	12,3 21,3
Motor start current	A	78 - 39	48 - 28	126 - 72	83 143
Motor protection level	IP	54			
Ignition transformer	V1 - V2	230V - 1x8 kV			230V - 1x5 kV
	I1 - I2	1A - 20 mA			
Operation		Intermittent (at least one stop every 24 h) or continuous (one stop every 72 hours)			
EMISSIONS					
Sound pressure	dB(A)	77	78,5	80,5	83
Sound output	W	--			
CO Emission	mg/kWh	< 20			
NOx Emission	mg/kWh	< 80			
APPROVAL					
Directive		2009/142 - 2006/42 - 2006/95 - 2004/108 EC			
Conforming to		EN 676			
Certification		CE-0085BS0267	CE-0085BS0268	CE-0085BS0266	CE-0085BT0414

(01) Centrifugal with reverse curve blades

(02) Centrifugal with forward curve blades

(03) 1/50/230~(±10%)

(04) 1/50-60/230~(±10%)

(05) 3N/50/230-400~(±10%)

(06) 3N/50-60/230-400~(±10%)

(07) 3N/50/400~(±10%)

Reference conditions:

Temperature: 20°C - Pressure: 1013,5 mbar - Altitude: 0 m a.s.l. - Noise measured at a distance of 1 meter.

Since the Company is constantly engaged in the production improvement, the aesthetic and dimensional features, the technical data, the equipment and the accessories can be changed. This document contains confidential and proprietary information of RIELLO S.p.A. Unless authorised, this information shall not be divulged, nor duplicated in whole or in part.

FIRING RATES

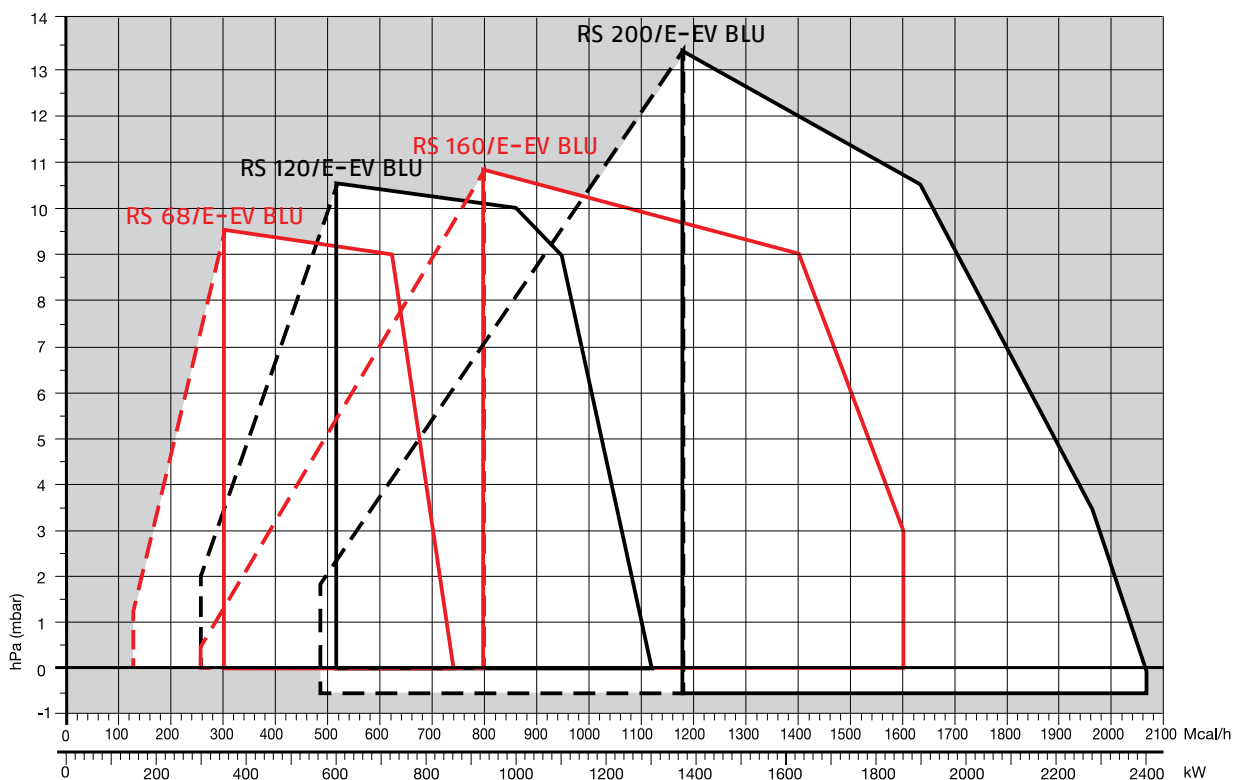
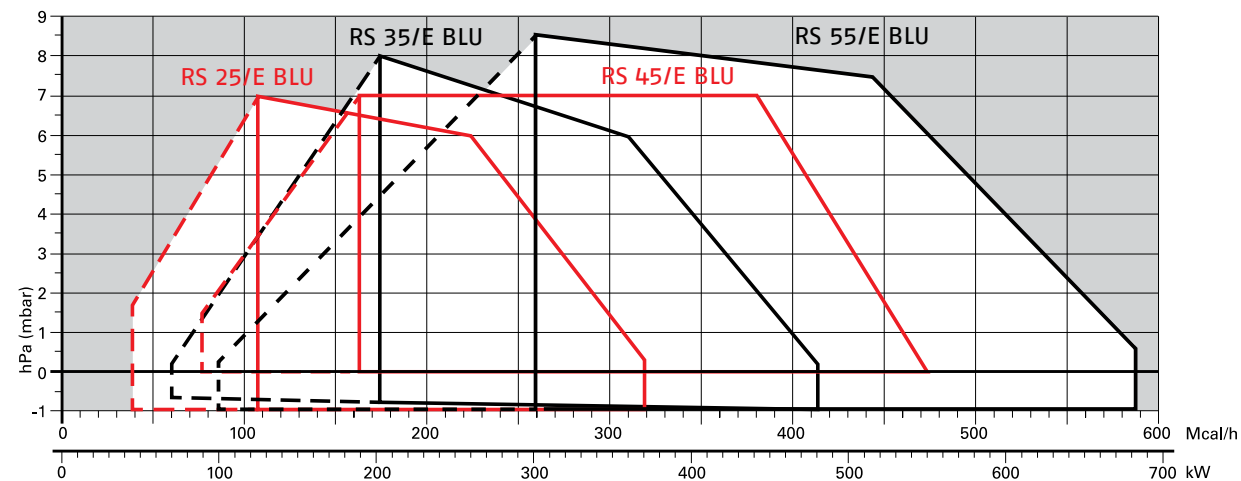

□ Useful working field for choosing the burner

▤ Modulation range

Test conditions conforming to EN 676:

Temperature: 20°C

Pressure: 1013,5 mbar

Altitude: 0 m a.s.l.

Fuel Supply

GAS TRAINS

The burners are fitted with a butterfly valve to regulate the fuel, controlled by a stepper motor with high accuracy position and absence of joint clearance and mechanical hysteresis. Fuel can be supplied either from the right or left hand sides. A maximum gas pressure switch stops the burner in case of excess pressure in the fuel line (as accessory on RS 25-35/E BLU). The gas train can be selected to best fit system requirements depending on the fuel output and pressure in the supply line. The gas train can be "Multibloc" type (containing the main components in a single unit) or "Composed" type (assembly of the single components).



Example of fuel adjusting stepper motors on RS 25/E BLU and RS 200/E BLU burners.

MB "THREADED"

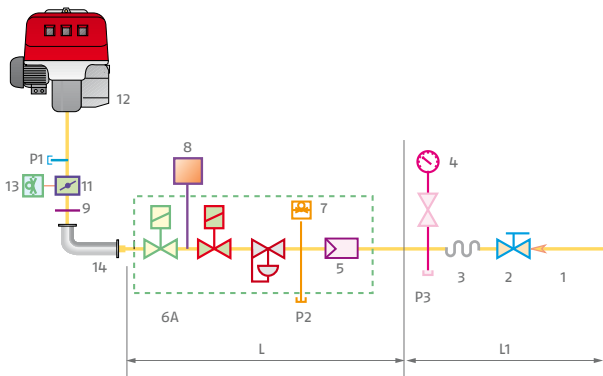

MBC "THREADED"

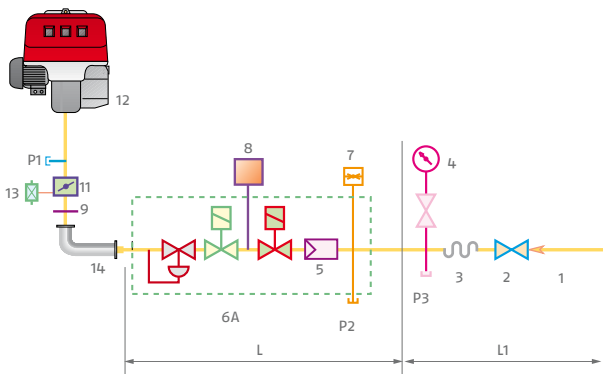

1	Gas input pipework
2	Manual valve
3	Anti-vibration joint
4	Pressure gauge with pushbutton cock
5	Filter
6A	Includes:
	- filter
	- operation valve
	- safety valve
	- pressure adjuster
7	Minimum gas pressure switch
8	Leak detection device, supplied as an accessory or incorporated, based on the gas train code.
9	Gasket
10	Pressure adjuster
11	Gas adjuster butterfly valve
12	Burner
13	Maximum gas pressure switch
14	Gas train-burner adaptor
P1	Combustion head pressure
P2	Upstream pressure of valves
P3	Upstream pressure of the filter
L	Gas train supplied separately, with the code given in the table.
L1	Installer's responsibility

MBC "FLANGED"

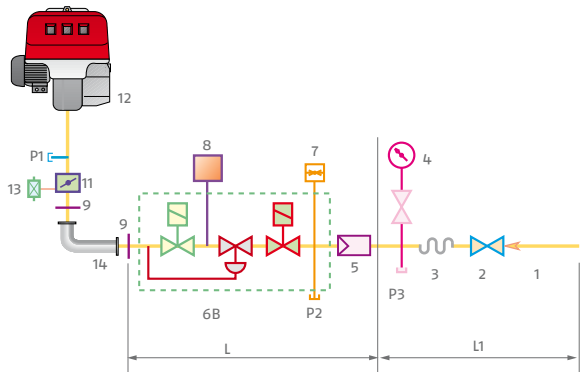

1	Gas input pipework
2	Manual valve
3	Anti-vibration joint
4	Pressure gauge with pushbutton cock
5	Filter
6A	Includes:
	- filter
	- operation valve
	- safety valve
	- pressure adjuster
6B	Includes:
	- operation valve
	- safety valve
	- pressure adjuster
6C	Includes:
	- operation valve
	- safety valve
7	Minimum gas pressure switch
8	Leak detection device, supplied as an accessory or incorporated, based on the gas train code.
9	Gasket
10	Pressure adjuster
11	Gas adjuster butterfly valve
12	Burner
13	Maximum gas pressure switch
14	Gas train-burner adaptor
P1	Combustion head pressure
P2	Upstream pressure of valves
P3	Upstream pressure of the filter
L	Gas train supplied separately, with the code given in the table
L1	Installer' responsibility

CB "FLANGED OR THREADED"

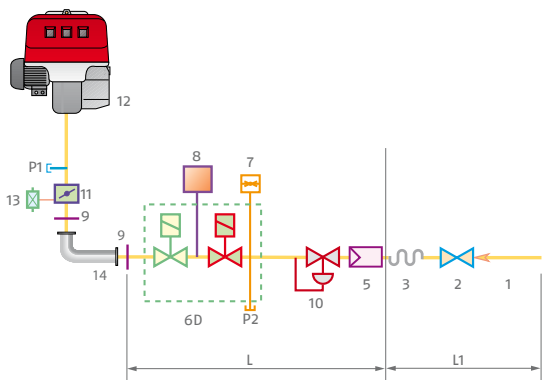

DMV "FLANGED OR THREADED"

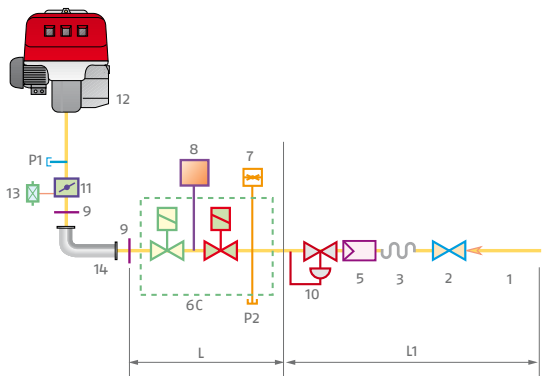

Gas trains are approved by standard EN 676 together with the burner.

The overall dimensions of the gas train depends on how they are constructed. The following table shows the maximum dimensions of the gas trains that can be fitted to RS/E BLU burners, intake and outlet diameters and seal control if fitted.

The gas train valves proofing control is an integrated function of REC 27 Electronic Cam device.

The maximum gas pressure of gas train "Multibloc" type is 360 mbar, and the one of gas train "Composed" type is 500 mbar.

The range of pressure in the MULTIBLOC with flange can be modified choosing the stabiliser spring (see gas train accessory).

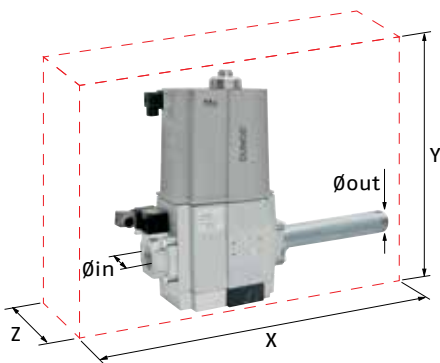

Example of gas train "MULTIBLOC" type without seal control (i.e. MBC 1200)

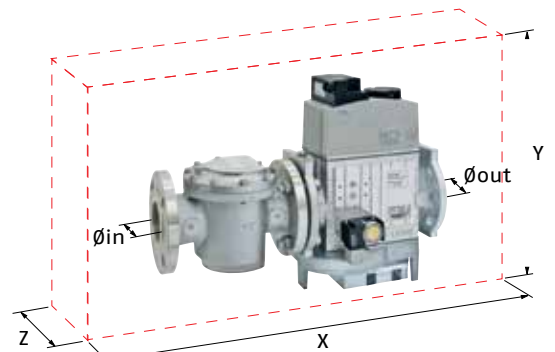

Example of gas train "COMPOSED" type without seal control (i.e. MBC 1900-3100-5000)



Example of gas train "CB" series with seal control

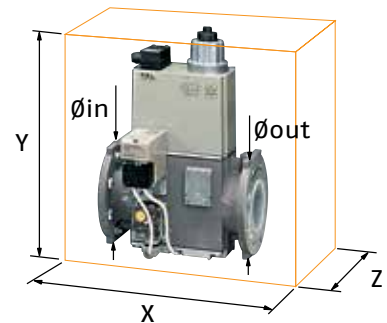

Example of gas train "DMV" series with seal control

GAS TRAIN

MODEL	CODE	Ø in	Ø out	X mm	Y mm	Z mm
MB 415/1 - RT 30	3970180	Rp 1-1/2"	Rp 1-1/2"	523	250	100
MB 415/1 CT RT 30	3970198	Rp 1-1/2"	Rp 1-1/2"	523	250	229
MB 415/1 - RT 52	3970250	Rp 1-1/2"	Rp 1-1/2"	523	250	100
MB 415/1 CT RT 52	3970253	Rp 1-1/2"	Rp 1-1/2"	523	250	229
MB 415/1 RSM 30	3970232	Rp 1-1/2"	Rp 1-1/2"	523	250	100
MB 420/1 RT 30	3970181	Rp 2"	Rp 2"	523	289	100
MB 420/1 CT RT 30	3970182	Rp 2"	Rp 2"	523	289	229
MB 420/1 RT 52	3970257	Rp 2"	Rp 2"	523	289	100
MB 420/1 CT RT 52	3970252	Rp 2"	Rp 2"	523	289	229
MB 420/1 RSM 30	3970233	Rp 2"	Rp 2"	523	289	100
MB 420/1 CT RSM 30	3970234	Rp 2"	Rp 2"	523	289	229

GAS TRAIN						
MODEL	CODE	∅ in	∅ out	X mm	Y mm	Z mm
MBC 1200/1 - RSM 60	3970221	Rp 2"	Rp 2"	528	424	161
MBC 1200/1 CT RSM 60	3970225	Rp 2"	Rp 2"	528	424	290
MBC 1900/1 - FSM 40	3970222	DN 65	DN 65	613	430	237
MBC 1900/1 CT FSM 40	3970226	DN 65	DN 65	613	430	298
MBC 3100/1 - FSM 40	3970223	DN 80	DN 80	633	500	240
MBC 3100/1 CT FSM 40	3970227	DN 80	DN 80	633	500	319
MBC 5000/1 - FSM 80	3970224	DN 100	DN 100	733	576	280
MBC 5000/1 CT FSM 80	3970228	DN 100	DN 100	733	576	348

GAS TRAIN						
MODEL	CODE	∅ in	∅ out	X mm	Y mm	Z mm
CB 512/1 - RSM 30	3970145	Rp 1-1/2"	Rp 1-1/2"	891	261	245
CB 512/1 - CT RSM 30	20045589	Rp 1-1/2"	Rp 1-1/2"	891	261	245
CB 520/1 - RSM 30	3970146	Rp 2"	Rp 2"	986	328	255
CB 520/1 - CT RSM 30	3970160	Rp 2"	Rp 2"	986	328	255
CB 525/1 - RSM 30	20044659	Rp 2"	Rp 2"	1025	356	285
CB 525/1 - CT RSM 30	20044660	Rp 2"	Rp 2"	1025	356	285
CB 5065/1 - FSM 30	3970147	DN 65	DN 65	906	356	285
CB 5065/1 CT FSM 30	3970161	DN 65	DN 65	906	356	285
CB 5080/1 - FSM 30	3970148	DN 80	DN 80	934	416	285
CB 5080/1 CT FSM 30	3970162	DN 80	DN 80	934	416	285
CB 50100/1 - FSM 30	3970149	DN 100	DN 100	1054	501	350
CB 50100/1 CT FSM 30	3970163	DN 100	DN 100	1054	501	350
CB 50125/1 - FSM 30	20015871	DN 125	DN 125	1164	780	400
CB 50125/1 CT FSM 30	3970196	DN 125	DN 125	1164	780	400

GAS TRAIN						
MODEL	CODE	∅ in	∅ out	X mm	Y mm	Z mm
DMV 512/1 - RSM - 0	20043035	Rp 1-1/2"	Rp 1-1/2"	490	292	245
DMV 512/1 -CT RSM - 0	20043036	Rp 1-1/2"	Rp 1-1/2"	490	292	245
DMV 512/1 - CQ RSM - 2	20043037	Rp 1-1/2"	Rp 1-1/2"	490	292	245
DMV 520/1 - RSM - 0	20043038	Rp 2"	Rp 2"	490	292	255
DMV 520/1 CT RSM - 0	20043039	Rp 2"	Rp 2"	490	292	255
DMV 520/1 CQ RSM - 2	20043040	Rp 2"	Rp 2"	490	292	255
DMV 525/1 - RSM - 0	20043053	Rp 2"	Rp 2"	530	338	270
DMV 525/1 CT RSM - 0	20043054	Rp 2"	Rp 2"	530	338	270
DMV 525/1 CQ RSM - 2	20043055	Rp 2"	Rp 2"	530	338	270
DMV 5065/1 - FSM - 0	20043041	DN 65	DN 65	290	338	270
DMV 5065/1 CT FSM - 0	20043042	DN 65	DN 65	290	338	270
DMV 5065/1 CQ FSM - 2	20043043	DN 65	DN 65	290	338	270
DMV 5080/1 - FSM - 0	20043044	DN 80	DN 80	310	397	290
DMV 5080/1 CT FSM - 0	20043045	DN 80	DN 80	310	397	290
DMV 5080/1 CQ FSM - 2	20043046	DN 80	DN 80	310	397	290
DMV 50100/1 - FSM - 0	20043047	DN 100	DN 100	350	449	307
DMV 50100/1 CT FSM - 0	20043048	DN 100	DN 100	350	449	307
DMV 50100/1 CQ FSM - 2	20043049	DN 100	DN 100	350	449	307
DMV 50125/1 - FSM - 0	20043050	DN 125	DN 125	400	554	333
DMV 50125/1 CT FSM - 0	20043051	DN 125	DN 125	400	554	333
DMV 50125/1 CQ FSM - 2	20043052	DN 125	DN 125	400	554	333

PRESSURE DROP DIAGRAM

The diagrams indicate the minimum pressure drop of the burners with the various gas trains that can be matched with them; at the value of these pressure drop add the combustion chamber pressure. The value thus calculated represents the minimum required input pressure to the gas train.

RS 25/E (NATURAL GAS)

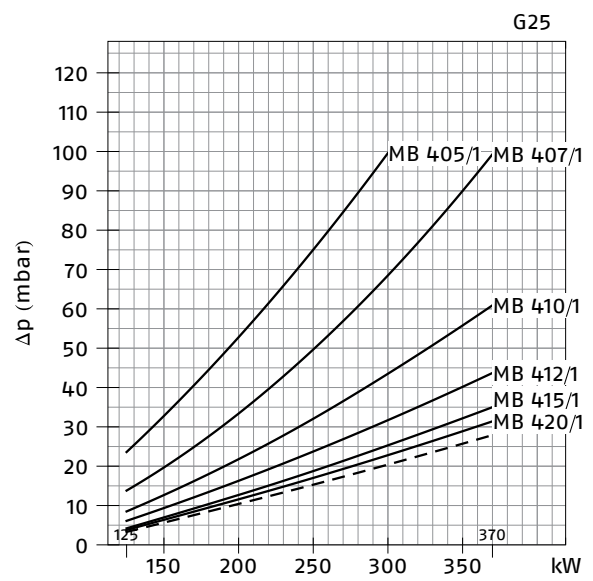
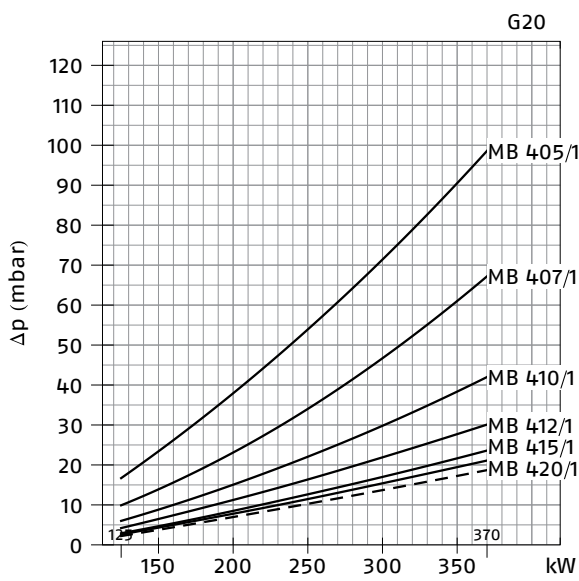

RS 25/E (NATURAL GAS)

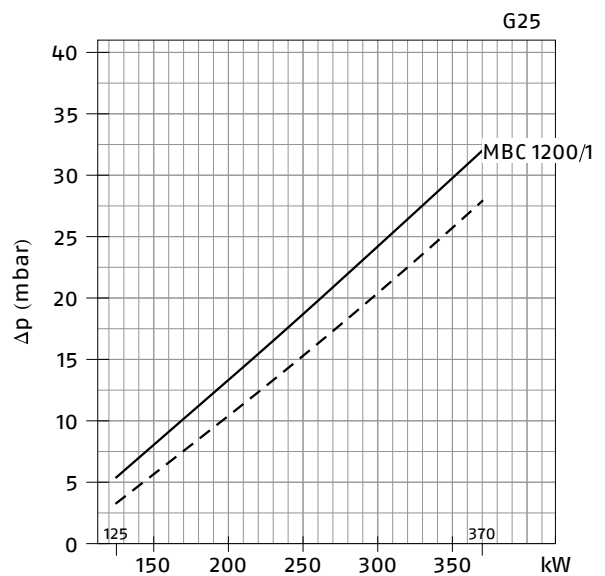
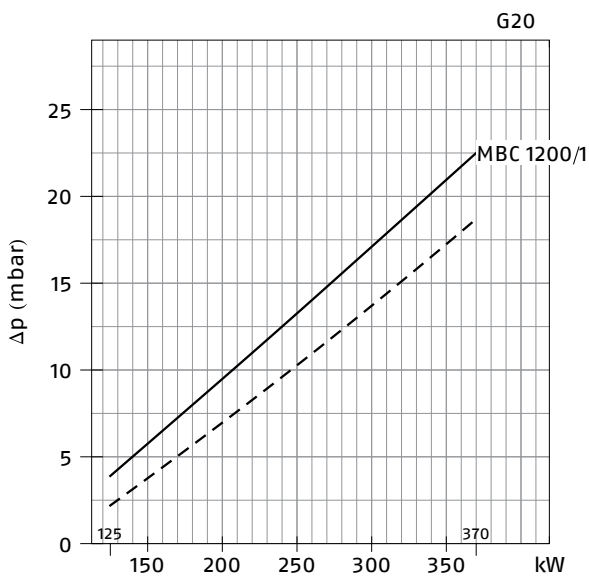

- Combustion head + gas butterfly valve + gas train
- - - Combustion head + gas butterfly valve

RS 25/E (NATURAL GAS)

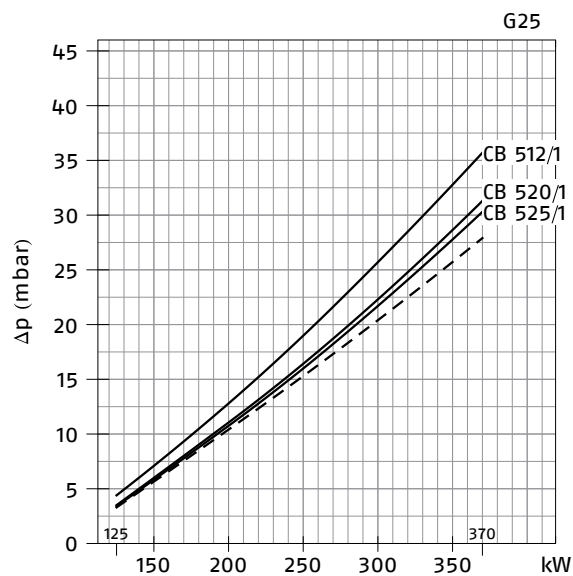
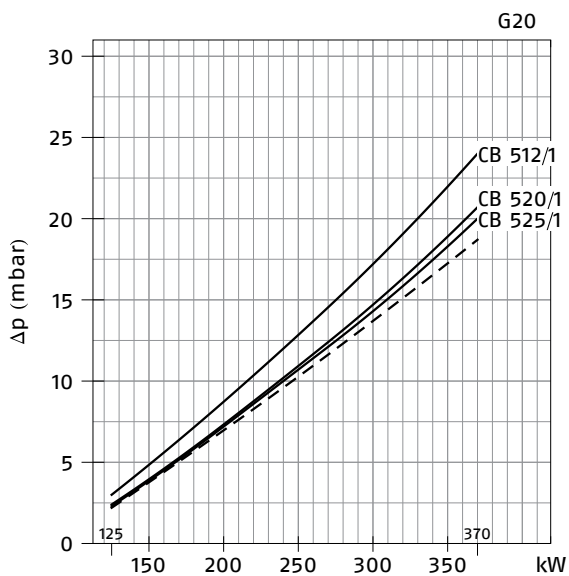

RS 25/E (NATURAL GAS)

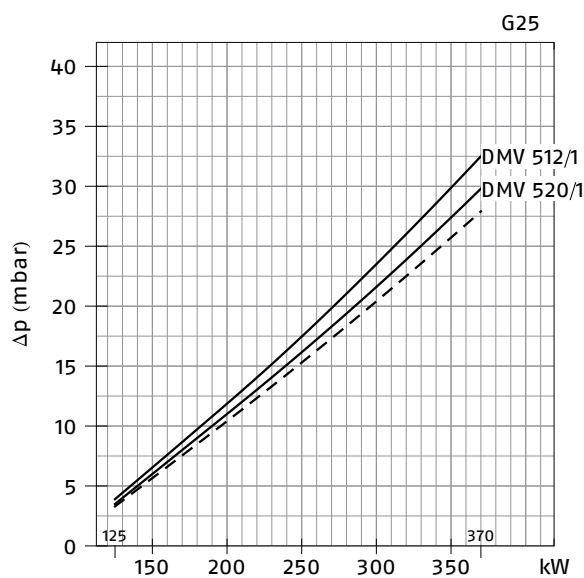
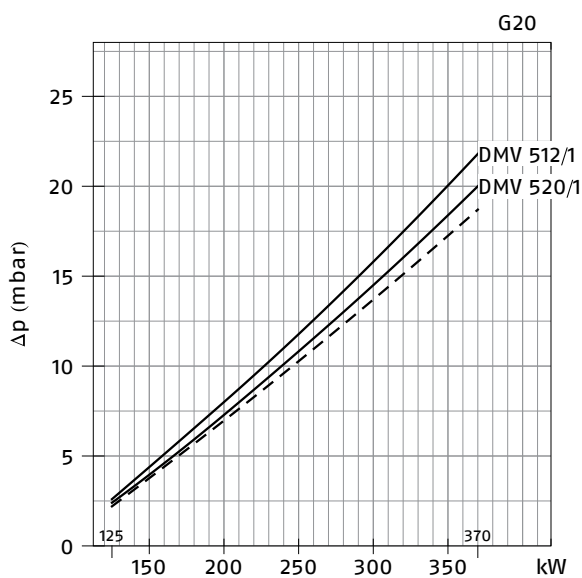

- Combustion head + gas butterfly valve + gas train
- - - Combustion head + gas butterfly valve

RS 35/E (NATURAL GAS)

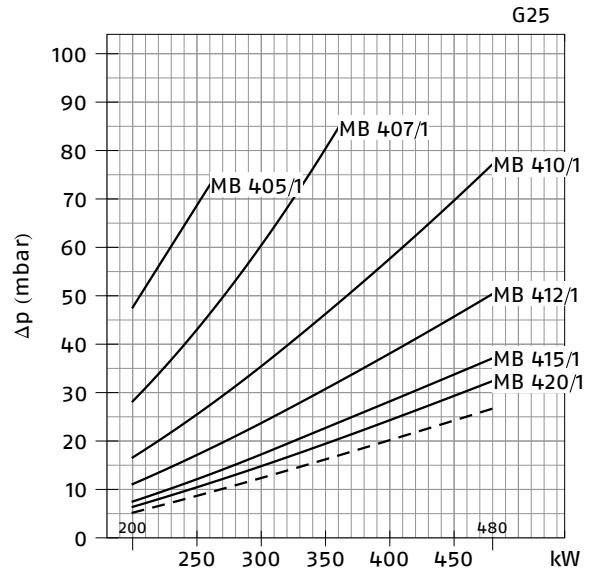
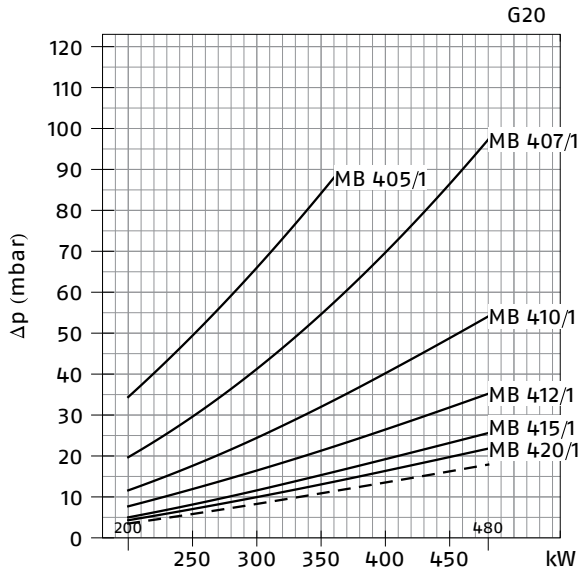

RS 35/E (NATURAL GAS)

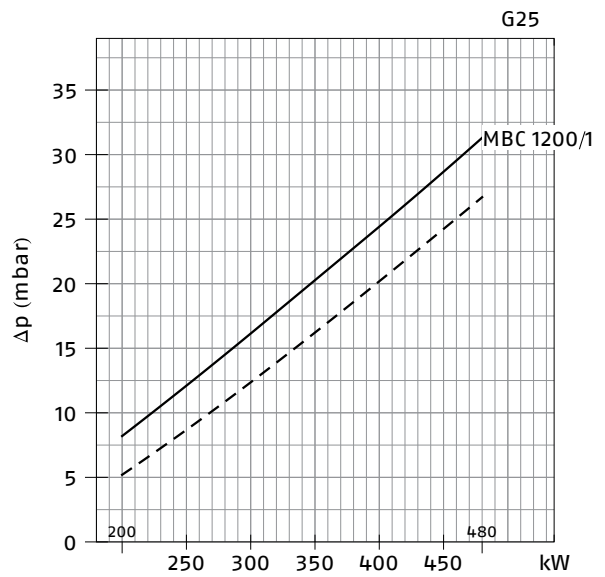
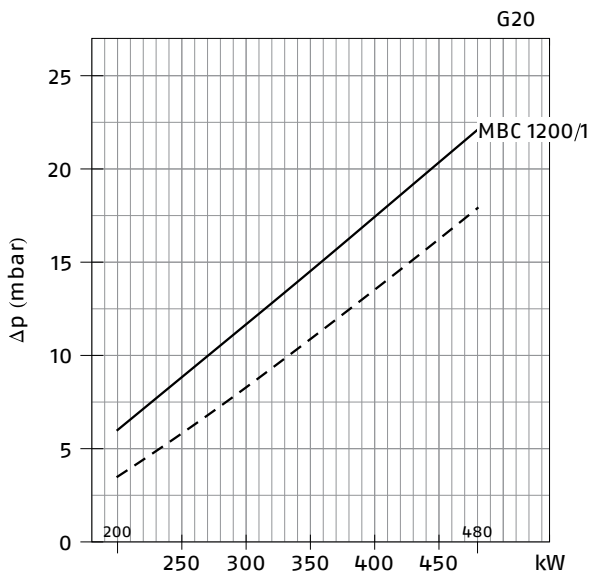

- Combustion head + gas butterfly valve + gas train
- - - Combustion head + gas butterfly valve

RS 35/E (NATURAL GAS)

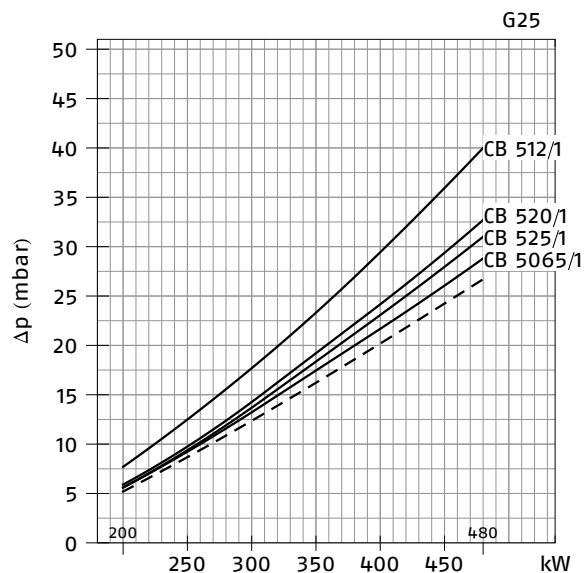
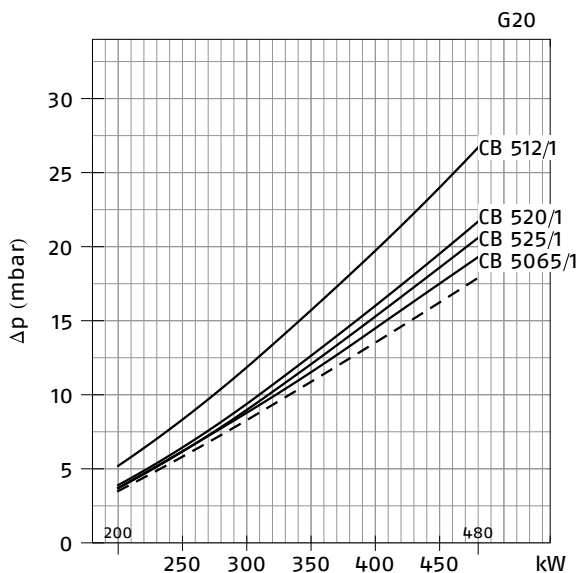

RS 35/E (NATURAL GAS)

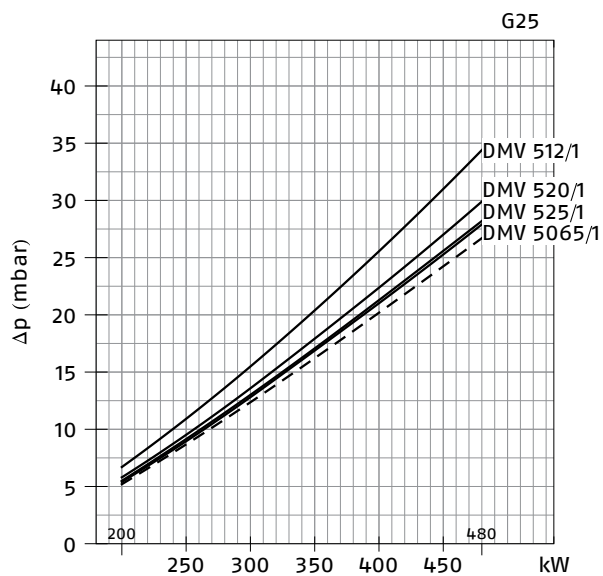
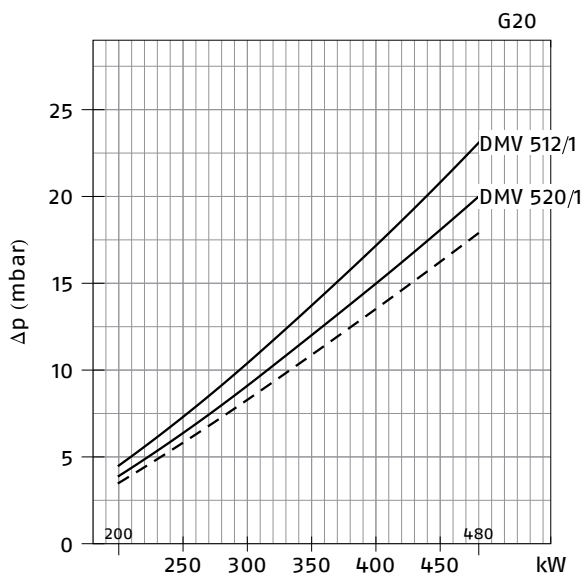

- Combustion head + gas butterfly valve + gas train
- - - Combustion head + gas butterfly valve

RS 45/E (NATURAL GAS)

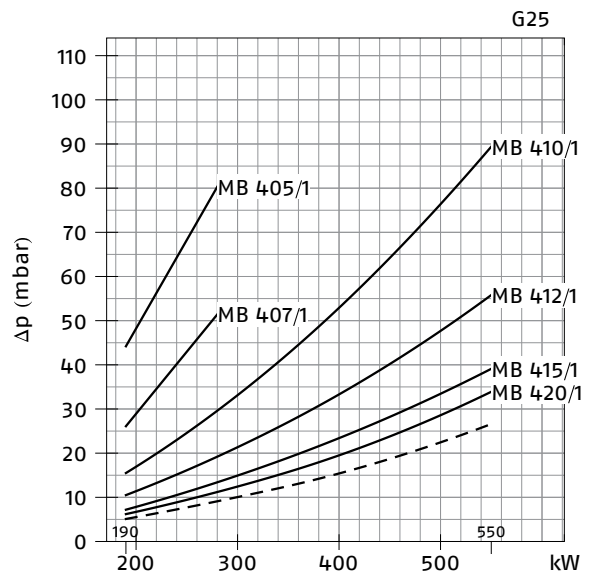
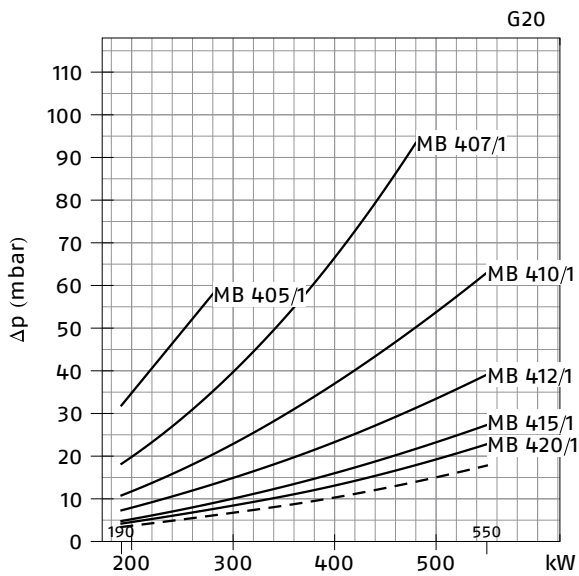

RS 45/E (NATURAL GAS)

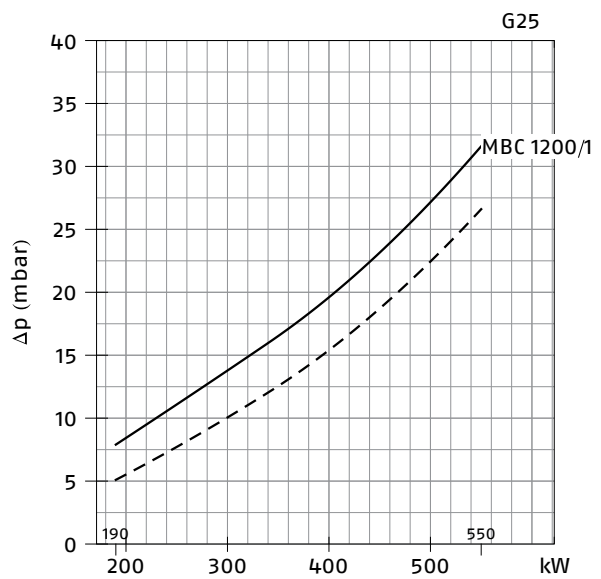
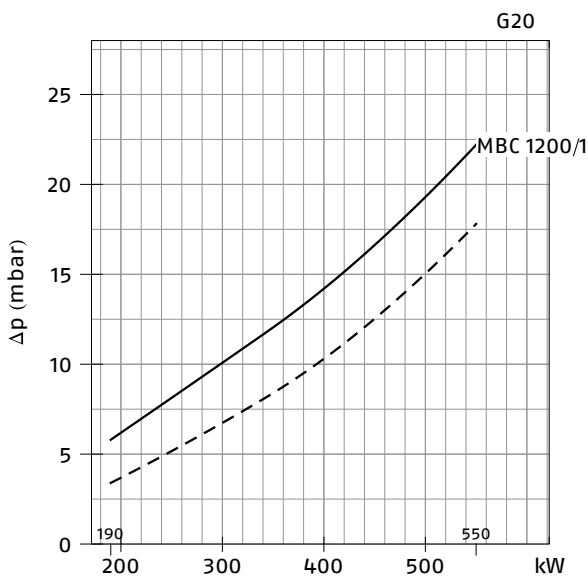

— Combustion head + gas butterfly valve + gas train
 - - - Combustion head + gas butterfly valve

RS 45/E (NATURAL GAS)

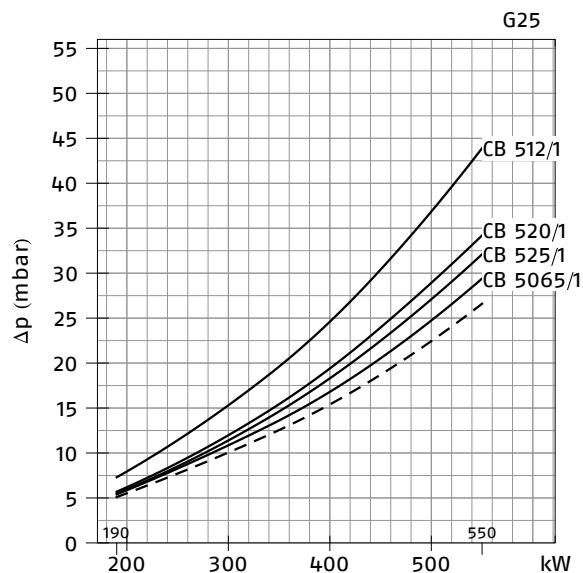
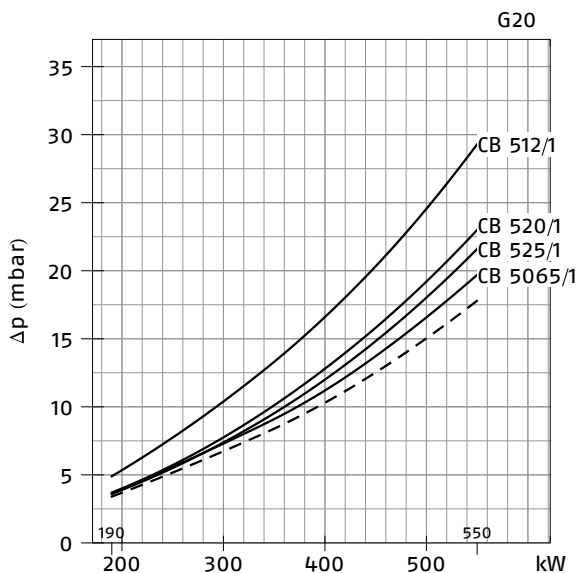

RS 45/E (NATURAL GAS)

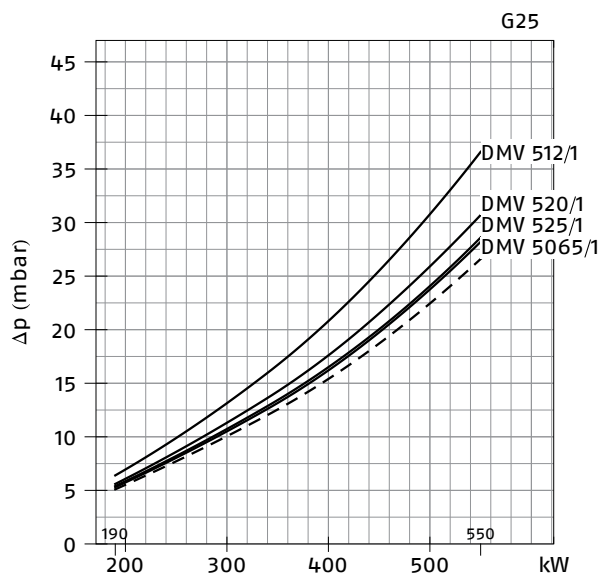
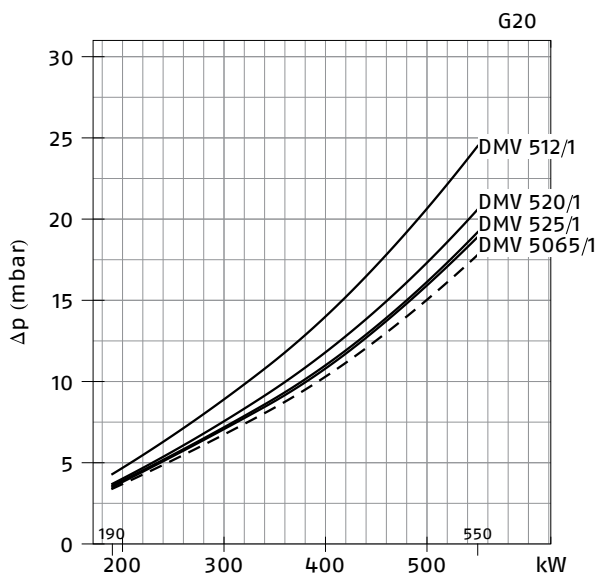

- Combustion head + gas butterfly valve + gas train
- - - Combustion head + gas butterfly valve

RS 55/E (NATURAL GAS)

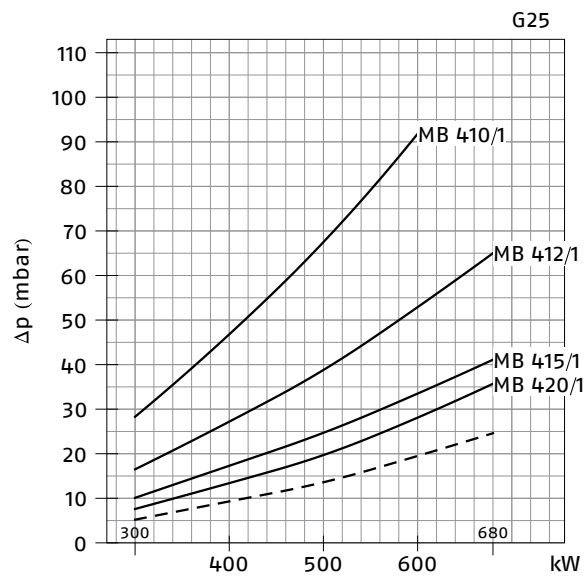
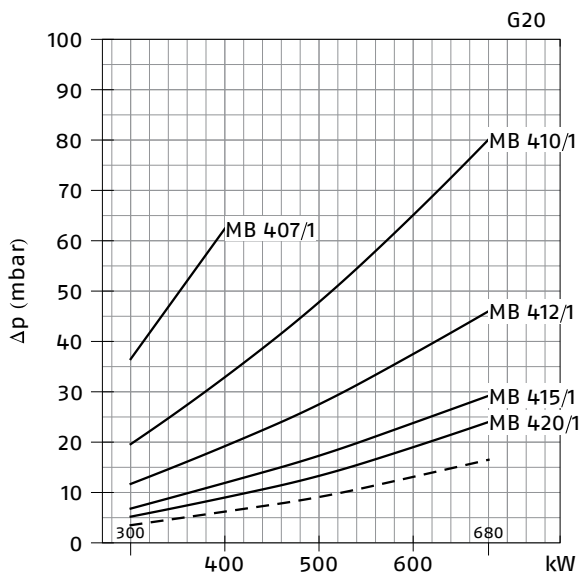

RS 55/E (NATURAL GAS)

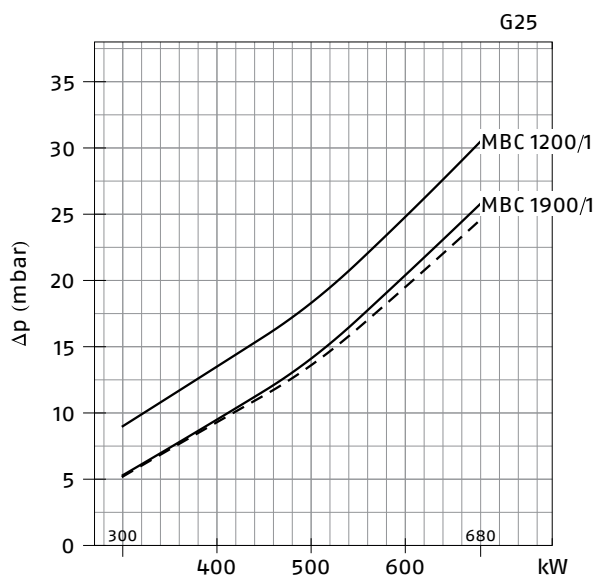
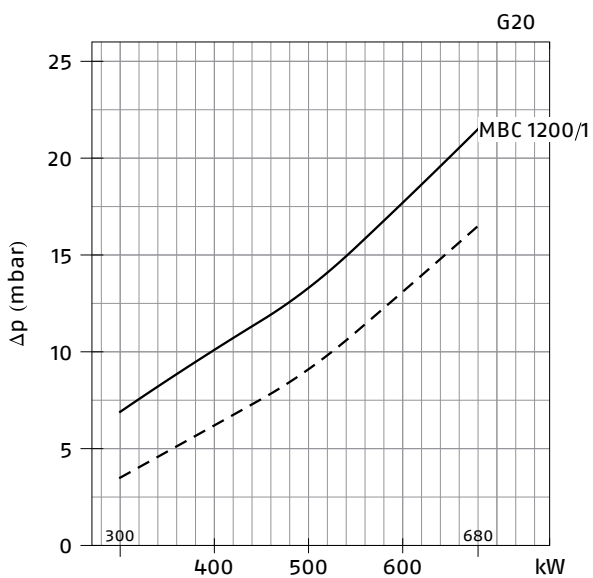

— Combustion head + gas butterfly valve + gas train
 - - - Combustion head + gas butterfly valve

RS 55/E (NATURAL GAS)

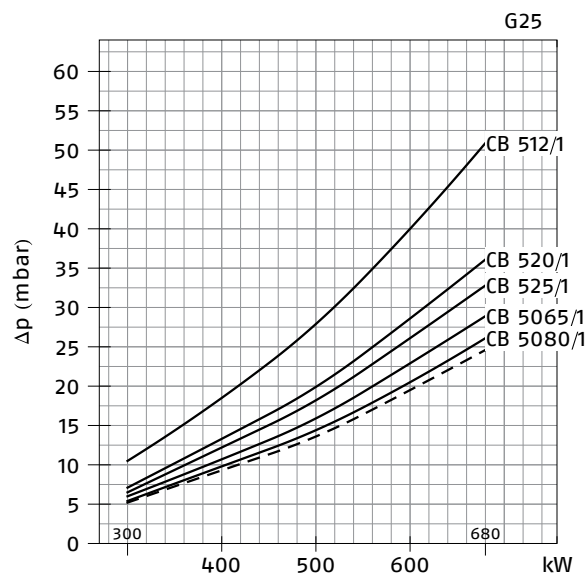
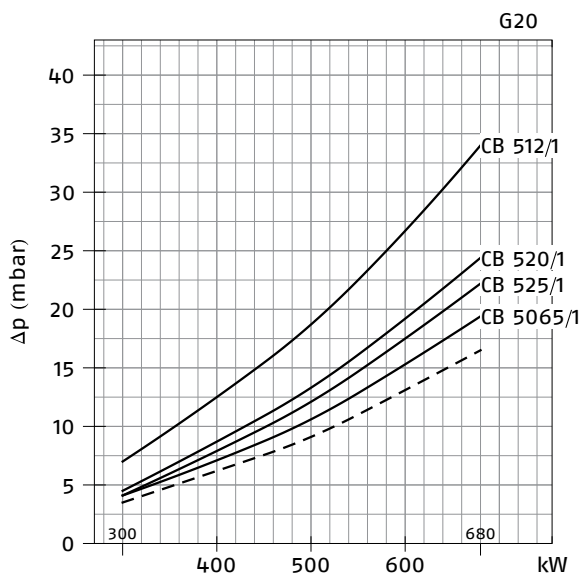

RS 55/E (NATURAL GAS)

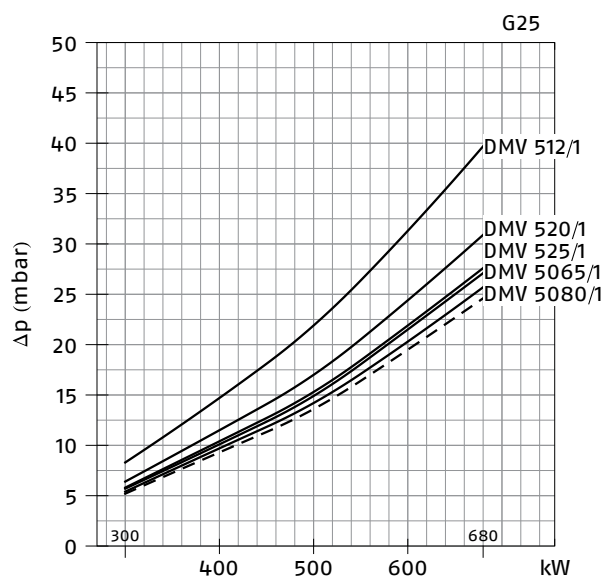
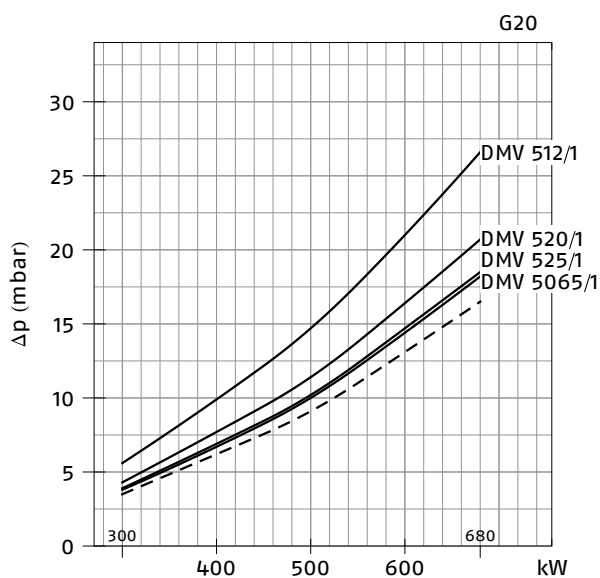

- Combustion head + gas butterfly valve + gas train
- - - Combustion head + gas butterfly valve

RS 68/E-EV (NATURAL GAS)

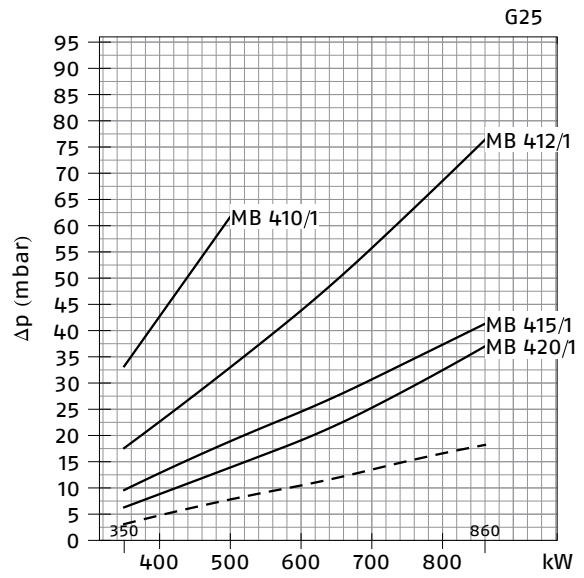
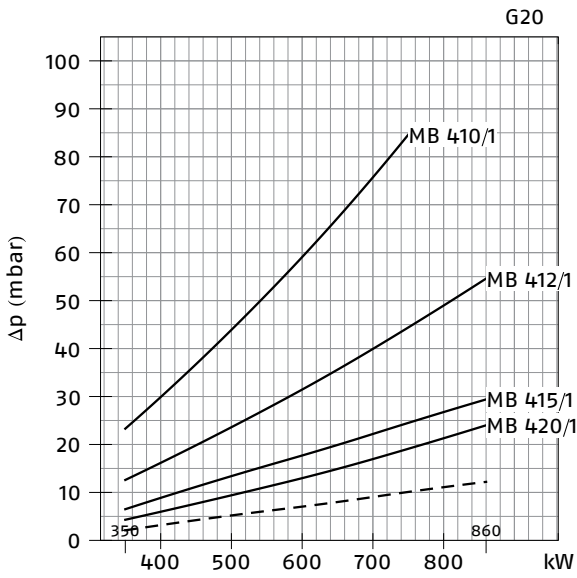

RS 68/E-EV (NATURAL GAS)

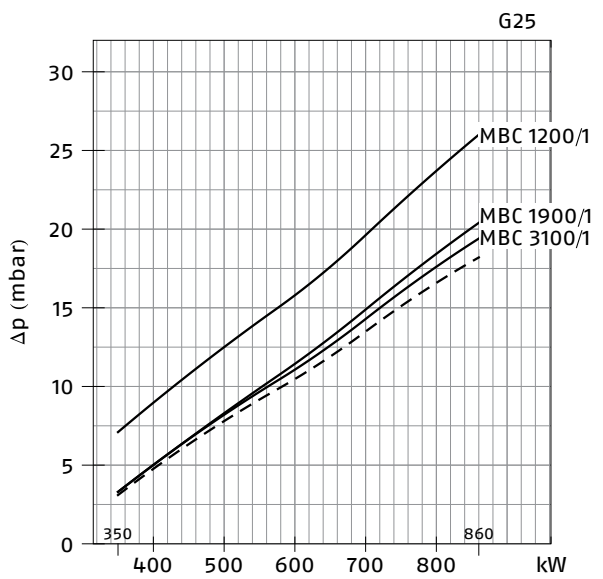
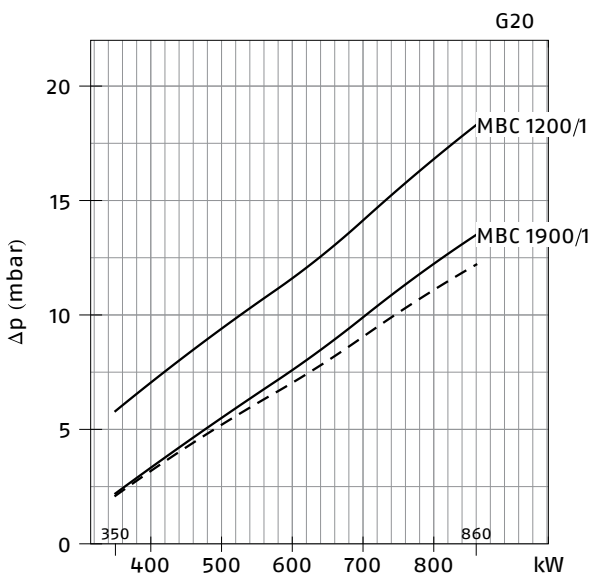

— Combustion head + gas butterfly valve + gas train
 - - - Combustion head + gas butterfly valve

RS 68/E-EV (NATURAL GAS)

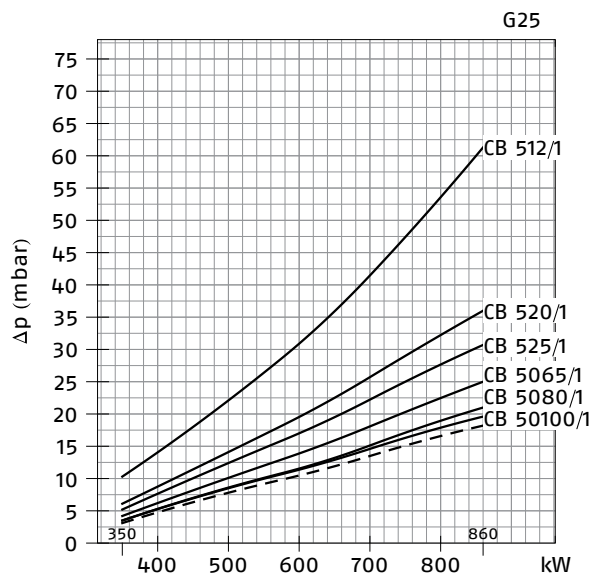
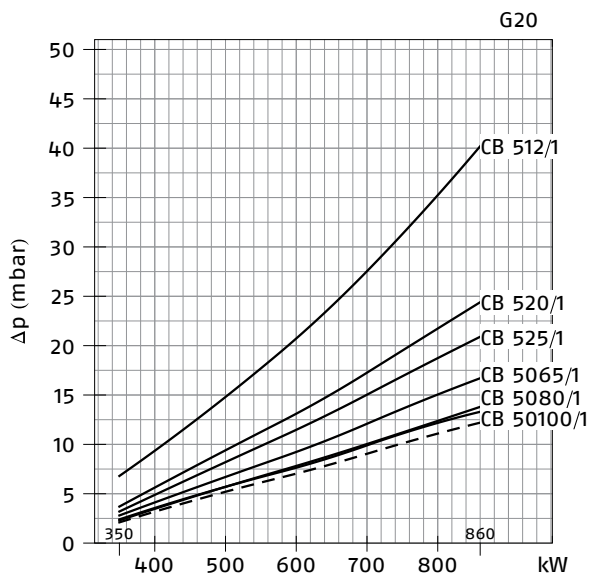

RS 68/E-EV (NATURAL GAS)

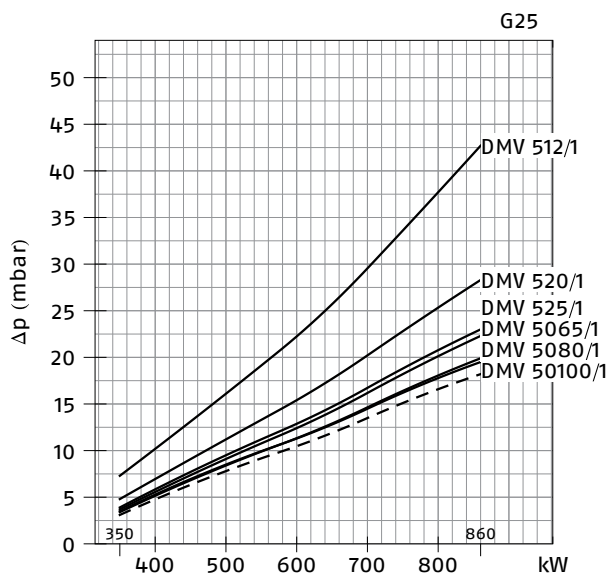
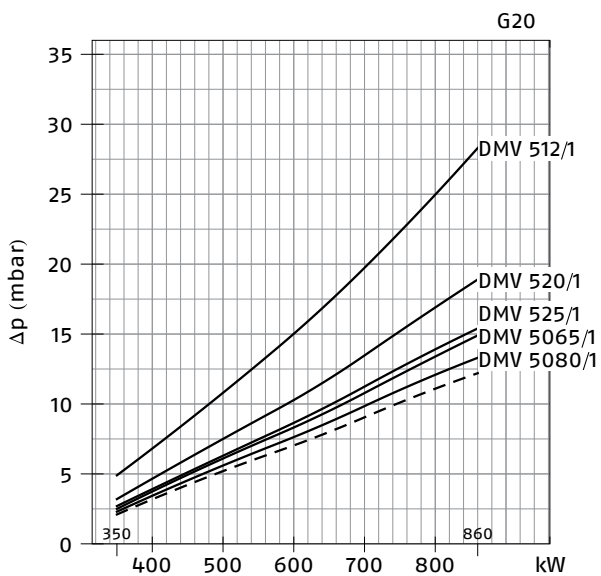

- Combustion head + gas butterfly valve + gas train
- - - Combustion head + gas butterfly valve

RS 120/E-EV (NATURAL GAS)

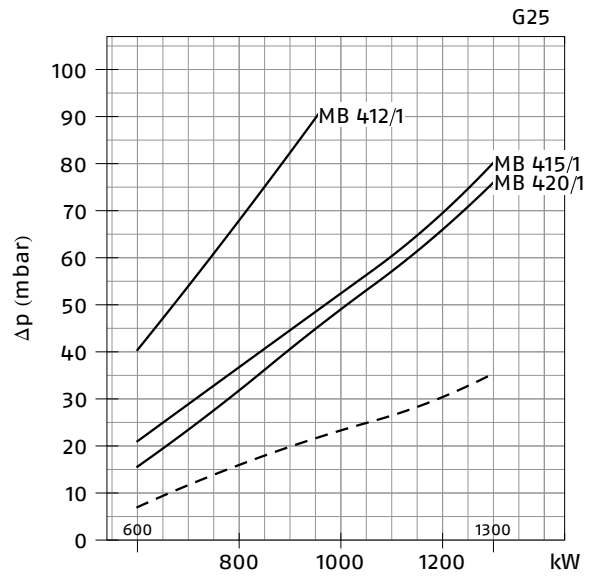
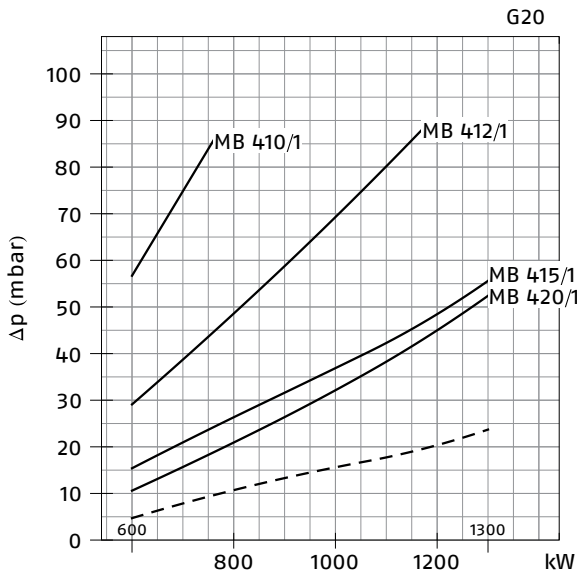

RS 120/E-EV (NATURAL GAS)

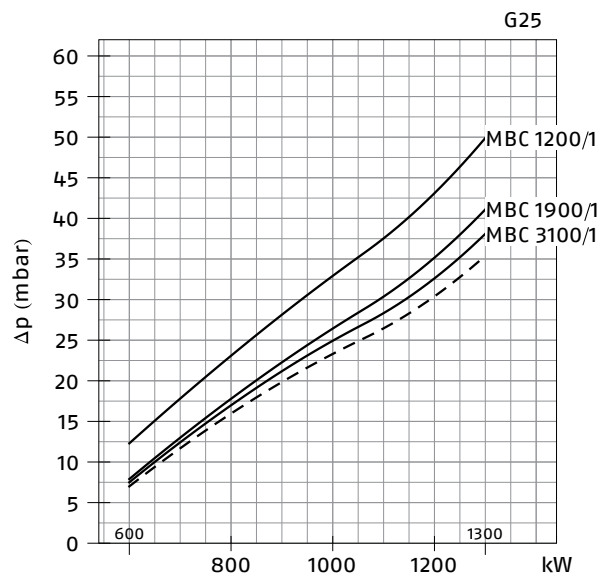
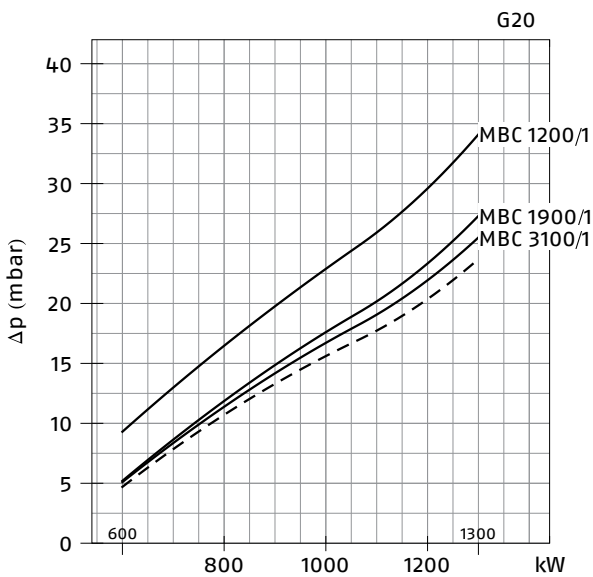

— Combustion head + gas butterfly valve + gas train
 - - - Combustion head + gas butterfly valve

RS 120/E-EV (NATURAL GAS)

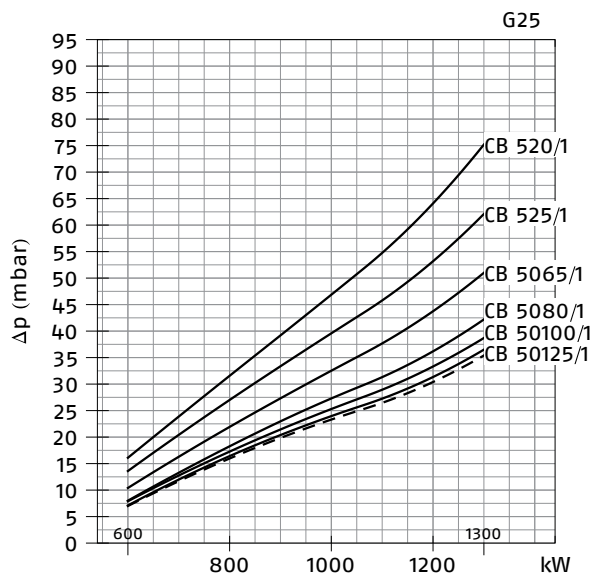
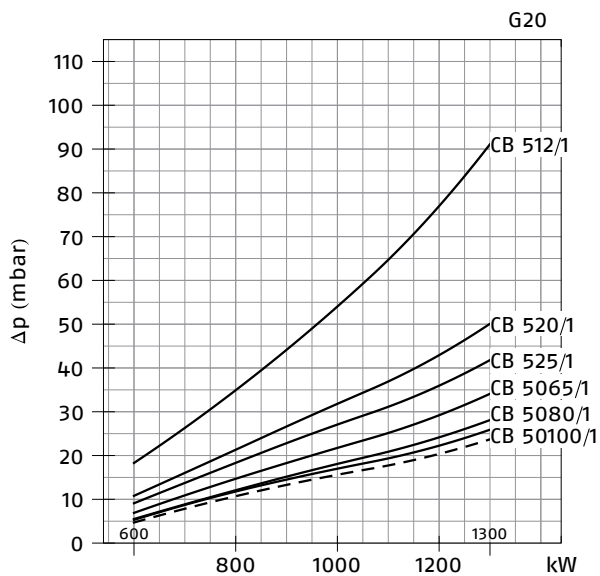

RS 120/E-EV (NATURAL GAS)

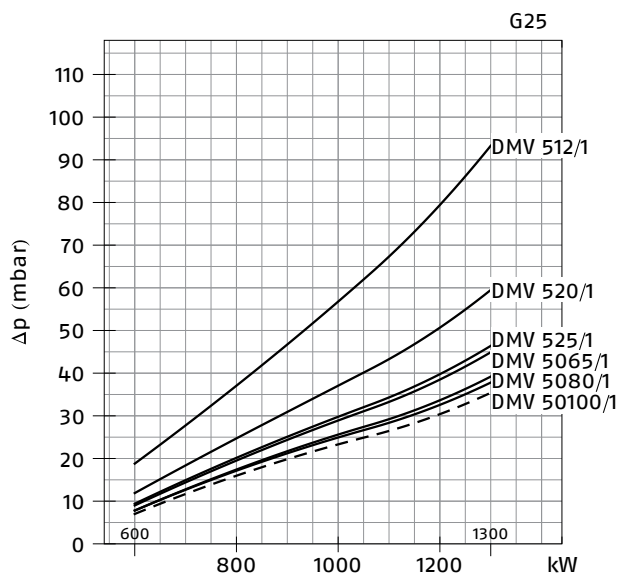
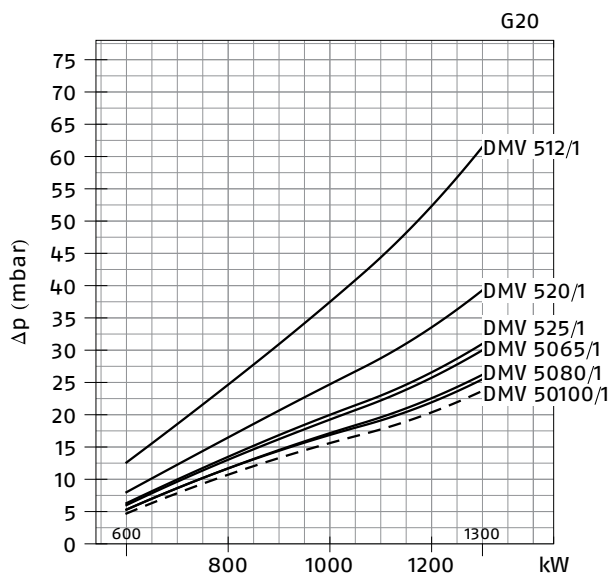

- Combustion head + gas butterfly valve + gas train
- - - Combustion head + gas butterfly valve

RS 160/E-EV (NATURAL GAS)

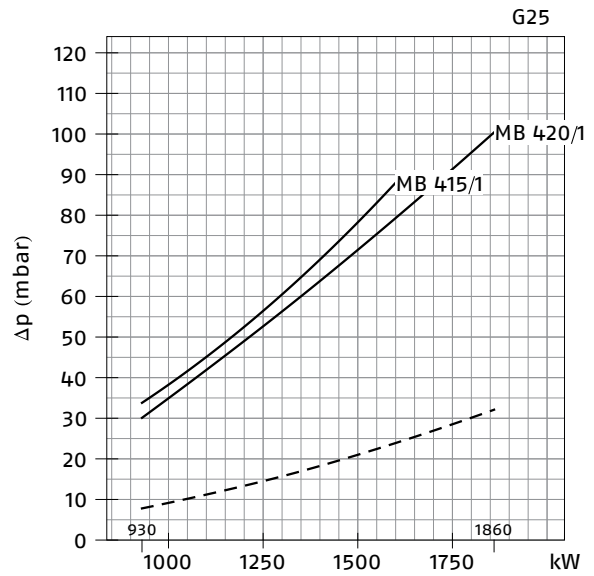
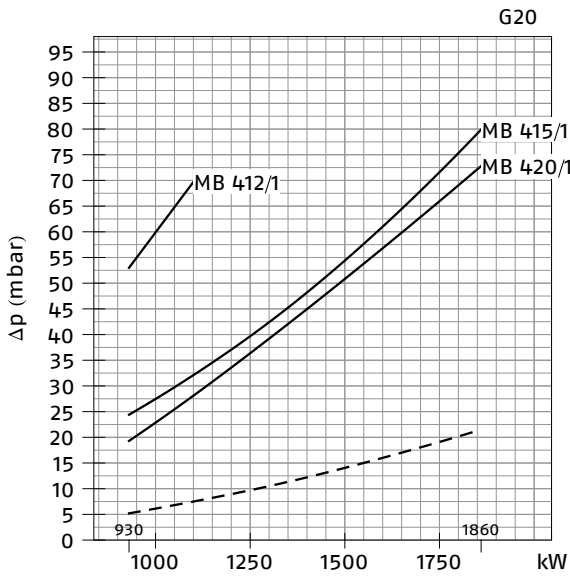

RS 160/E-EV (NATURAL GAS)

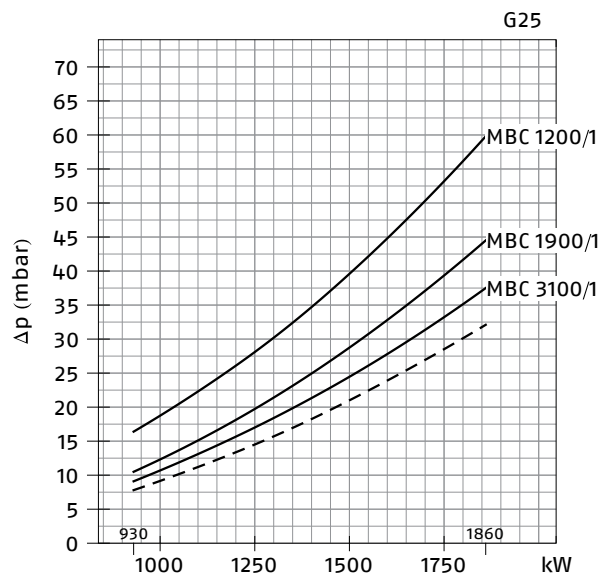
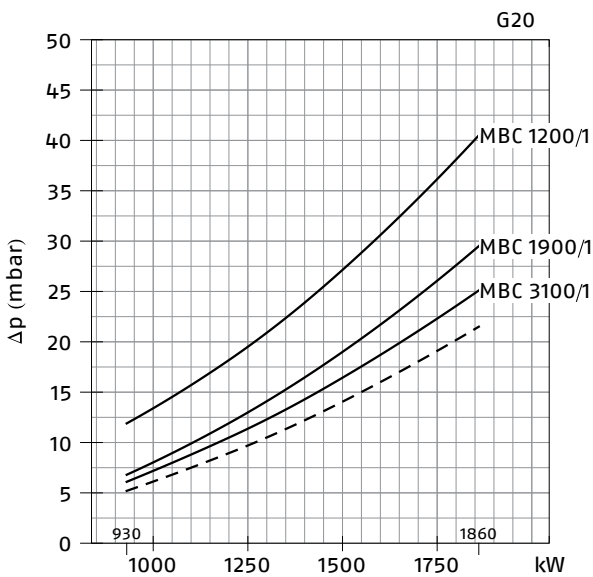

— Combustion head + gas butterfly valve + gas train
 - - - Combustion head + gas butterfly valve

RS 160/E-EV (NATURAL GAS)

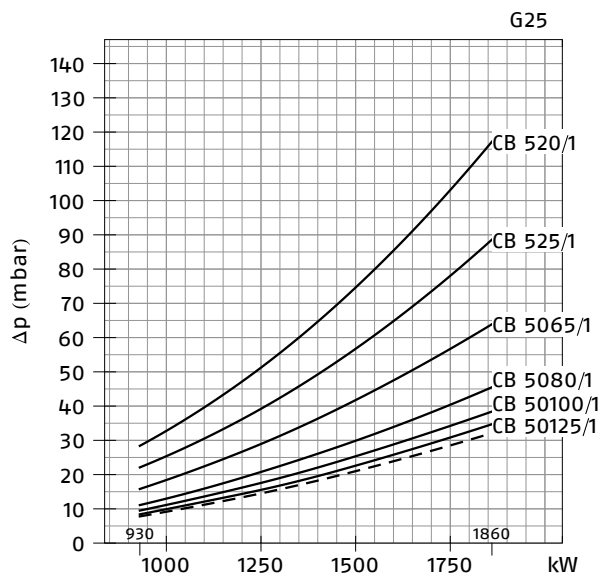
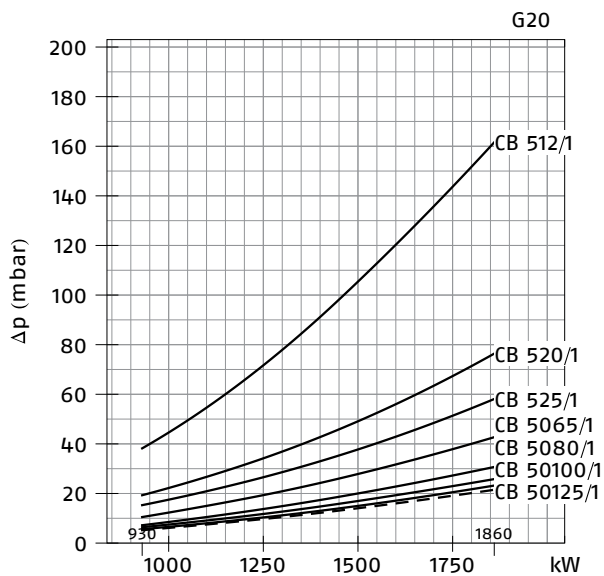

RS 160/E-EV (NATURAL GAS)

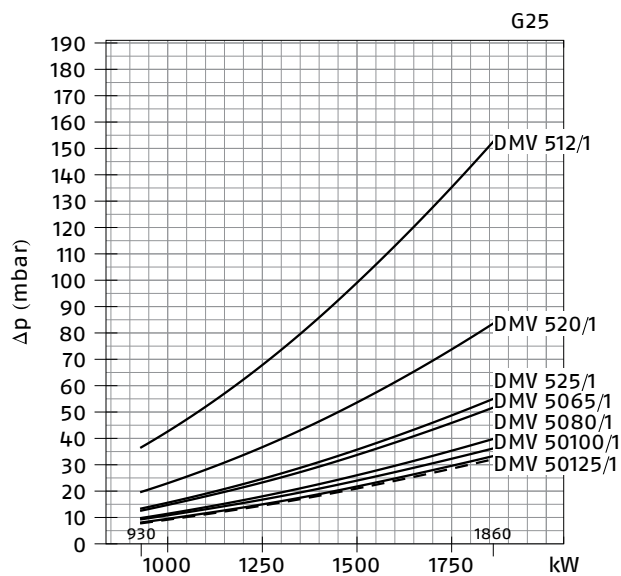
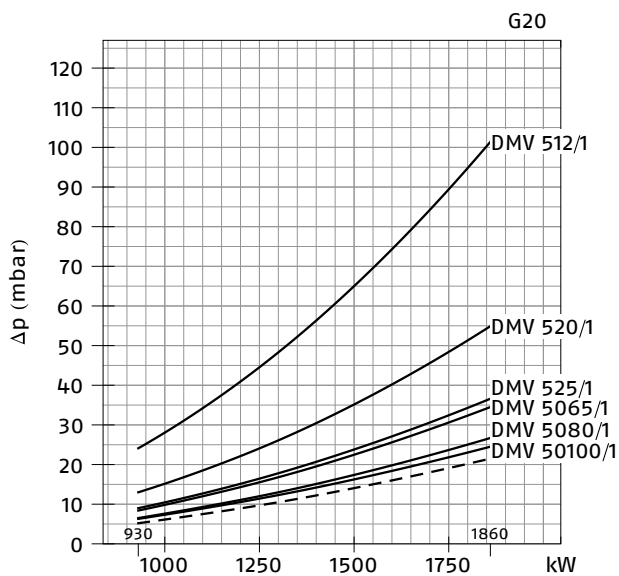

- Combustion head + gas butterfly valve + gas train
- - - Combustion head + gas butterfly valve

RS 200/E-EV (NATURAL GAS)

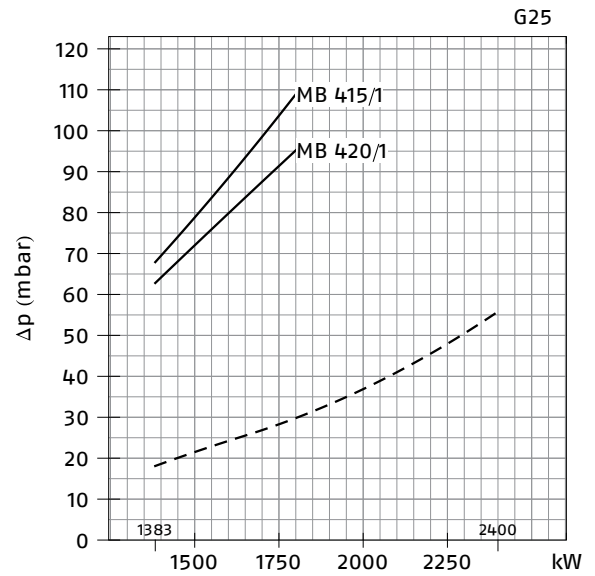
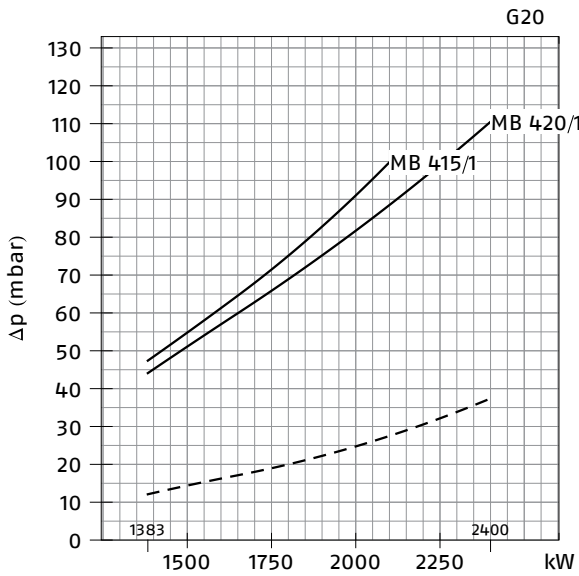

RS 200/E-EV (NATURAL GAS)

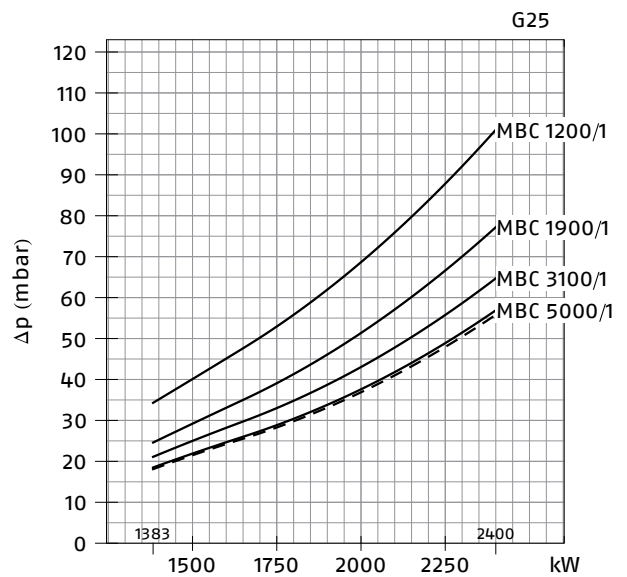
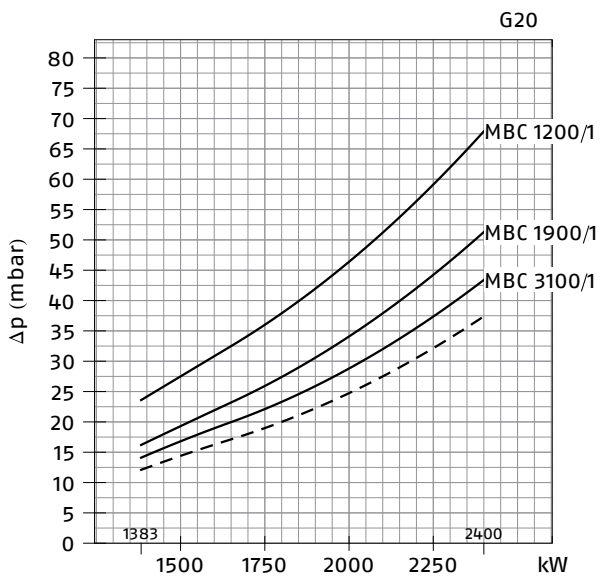

- Combustion head + gas butterfly valve + gas train
- - - Combustion head + gas butterfly valve

RS 200/E-EV (NATURAL GAS)

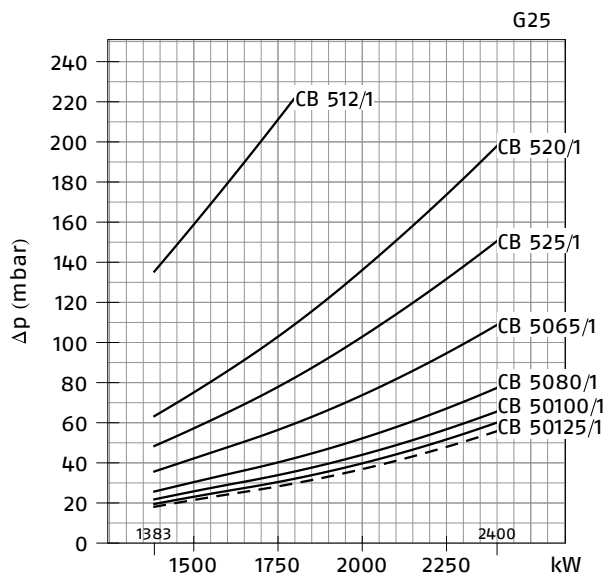
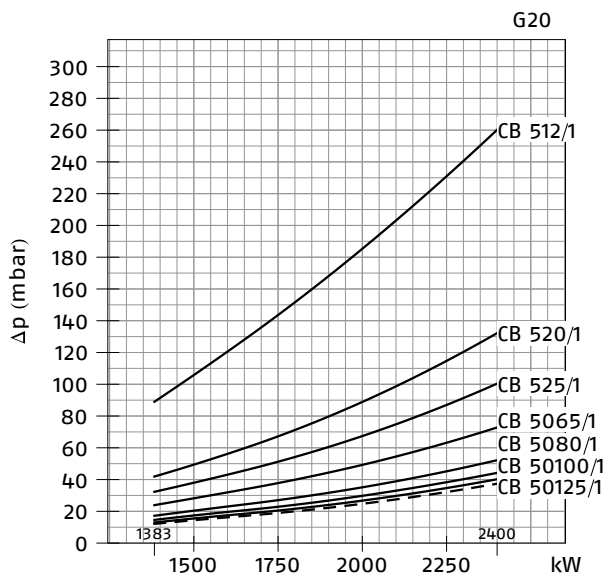

RS 200/E-EV (NATURAL GAS)

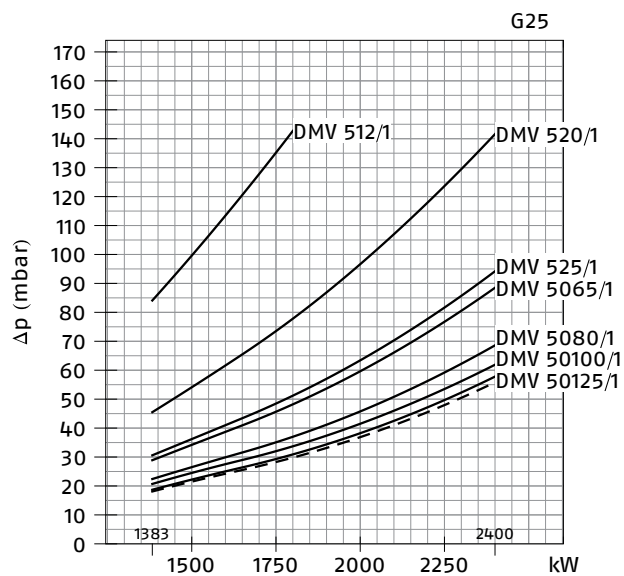
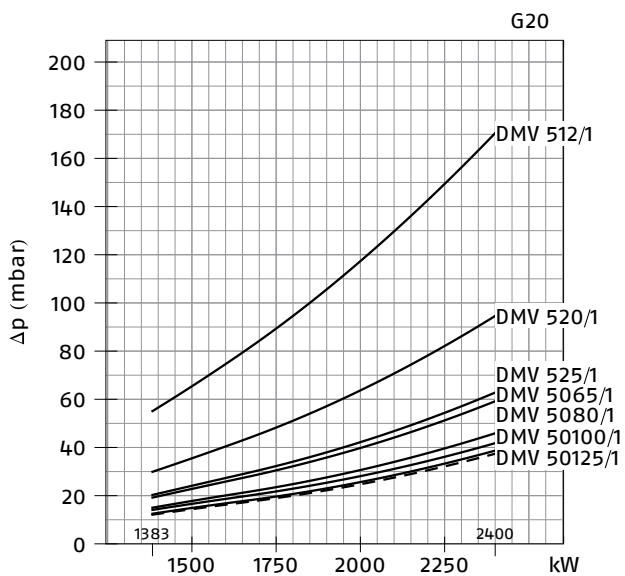

— Combustion head + gas butterfly valve + gas train
 - - - Combustion head + gas butterfly valve

GAS TRAIN			LEAK DETECTION CONTROL DEVICE	ADAPTER CODE /E		
CODE	MODEL	C.Q.	CODE	RS 25	RS 35-45	RS 55
			PVP			
3970599	MB 407/1 - RT 52	-	3010344	3000824		3000824 + 3000843
3970258	MB 410/1 - RT 52	-	3010344	3010124		3010126
3970600	MB 410/1 - RT 52	-	3010344	3000824		3000824 + 3000843
3970256	MB 412/1 - RT 52	-	3010344	-	-	3000843
3970250	MB 415/1 - RT 52	-	3010344	-	-	
3970257	MB 420/1 - RT 52	-	3010344	3000822		-
3970221	MBC 1200/1 - RSM 60	-	3010344			-
3970222	MBC 1900/1 - FSM 40	-	3010344	●	●	3000825
3970145	CB 512/1 - RSM 30	-	3010344	-	-	3000843
3970146	CB 520/1 - RSM 30	-	3010344	3000822		-
20044659	CB 525/1 - RSM 30	-	3010344			-
3970147	CB 5065/1 - FSM 30	-	3010344	●	●	3000825
20043035	DMV 512/1 - RSM -0	-	3010344	-	-	3000843
20043037	DMV 512/1 CQ RSM -2	◆	-	-	-	
20043038	DMV 520/1 - RSM -0	-	3010344	3000822		-
20043040	DMV 520/1 CQ RSM -2	◆	-			-
20043053	DMV 525/1 - RSM -0	-	3010344	●	3000822	-
20043055	DMV 525/1 CQ RSM -2	◆	-	●		-
20043041	DMV 5065/1 - FSM -0	-	3010344	●	3000825	
20043043	DMV 5065/1 CQ FSM -2	◆	-	●		
20043044	DMV 5080/1 - FSM -0	-	3010344	●	●	3000826
20043046	DMV 5080/1 CQ FSM -2	◆	-	●	●	

GAS TRAIN			LEAK DETECTION CONTROL DEVICE	ADAPTER CODE /E-/EV			
CODE	MODEL	C.Q.	CODE	RS 68	RS 120	RS 160	RS 200
			PVP				
3970600	MB 410/1 - RT 52	-	3010344	3000824 + 3000843		●	●
3970258	MB 410/1 - RT 52	-	3010344	3010126		●	●
20053265	MB 410/1 - CQ RSM 52	◆	-			●	●
20057696	MB 410/1 - CQ RSM 52	◆	-	3010126		●	●
3970256	MB 412/1 - RT 52	-	-			●	●
20053266	MB 412/1 - CQ RSM 52	◆	-	3000843 (*)			●
20057695	MB 412/1 - CQ RSM 52	◆	-			●	●
3970250	MB 415/1 - RT 52	-	3010344	3000843 (*)			
20053269	MB 415/1 - CQ RSM 52	◆	-				
20057694	MB 415/1 - CQ RSM 52	◆	-				
3970257	MB 420/1 - RT 52	-	3010344	-	-	-	-
20053270	MB 420/1 - CQ RSM 52	◆	-	-	-	-	-
20057693	MB 420/1 - CQ RSM 52	◆	-	-	-	-	-
3970221	MBC 1200/1 - RSM 60	-	3010344	-	-	-	-
3970222	MBC 1900/1 - FSM 40	-	3010344	3000825			
3970223	MBC 3100/1 - FSM 40	-	3010344	3000826			
3970224	MBC 5000/1 - FSM 80	-	3010344	●	●	●	3010370 + 3000826
3970145	CB 512/1 - RSM 30	-	3010344	3000843			
3970146	CB 520/1 - RSM 30	-	3010344	-	-	-	-
20044659	CB 525/1 - RSM 30	-	3010344	-	-	-	-

GAS TRAIN			LEAK DETECTION CONTROL DEVICE	ADAPTER CODE /E-/EV			
CODE	MODEL	C.Q.	CODE	RS 68	RS 120	RS 160	RS 200
			PVP				
3970147	CB 5065/1 - FSM 30	-	3010344	3000825			
3970148	CB 5080/1 - FSM 30	-	3010344	3000826			
3970149	CB 50100/1 - FSM 30	-	3010344	3010370 + 3000826			
20015871	CB 50125/1 - FSM 30	-	3010344	●	3010224 + 3000826		
20043035	DMV 512/1 - RSM -0	-	3010344	3000843			
20043037	DMV 512/1 CQ RSM -2	◆	-				
20043038	DMV 520/1 - RSM -0	-	3010344	-	-	-	-
20043040	DMV 520/1 CQ RSM -2	◆	-	-	-	-	-
20043053	DMV 525/1 - RSM -0	-	3010344	-	-	-	-
20043055	DMV 525/1 CQ RSM -2	◆	-	-	-	-	-
20043041	DMV 5065/1 - FSM -0	-	3010344	3000825			
20043043	DMV 5065/1 CQ FSM -2	◆	-				
20043044	DMV 5080/1 - FSM -0	-	3010344	3000826			
20043046	DMV 5080/1 CQ FSM -2	◆	-				
20043047	DMV 50100/1 - FSM -0	-	3010344	3010370 + 3000826			
20043049	DMV 50100/1 CQ FSM -2	◆	-				
20043050	DMV 50125/1 - FSM -0	-	3010344	●	●	3010224 + 3000826	
20043052	DMV 50125/1 CQ FSM -2	◆	-	●	●		

The valves seal control device is compulsory (conforming to EN 676) on gas trains to burners with a maximum output over 1200 kW.

The seal control function is managed by REC control box, by installation on gas train of a pressure switch; it is included as standard equipment on RS 120/E-EV-160/E-EV-200/E-EV BLU models.

Key to layout

C.Q. Additional pressure switch for leak detection control device:

- gas train not equipped with leak detection control device; this device can be ordered separately - see PVP column - and installed later.
- ◆ gas train equipped with leak detection control device.

PVP Pressure valve proving kit.

- Not available

Selecting the Fuel Supply lines

The following diagram enables pressure drop in a pre-existing gas line to be calculated and to select the correct gas train.

The diagram can also be used to select a new gas line when fuel output and pipe length are known. The pipe diameter is selected on the basis of the desired pressure drop. The diagram uses methane gas as reference; if another gas is used, conversion coefficient and a simple formula (on the diagram) transform the gas output to a methane equivalent (refer to figure A). Please note that the gas train dimensions must take into account the back pressure of the combustion chamber during operations.

Control of the pressure drop in an existing gas line or selecting a new gas supply line.

The methane output equivalent is determined by the formula fig. A on the diagram and the conversion coefficient.

Once the equivalent output has been determined on the delivery scale (\dot{V}), shown at the top of the diagram, move vertically downwards until you cross the line that represents the pipe diameter; at this point, move horizontally to the left until you meet the line that represents the pipe length.

Once this point is established you can verify, by moving vertically downwards, the pipe pressure drop of on the bottom scale below (mbar).

By subtracting this value from the pressure measured on the gas meter, the correct pressure value will be found for the choice of gas train.

- Example:
- gas used G25
 - gas output 9.51 mc/h
 - pressure at the gas meter 20 mbar
 - gas line length 15 m
 - conversion coefficient 0.62 (see figure A)

- equivalent methane output $\dot{V} = \left[\frac{9.51}{0.62} \right] = 15.34 \text{ mc/h}$

- once the value of 15.34 has been identified on the output scale (\dot{V}), moving vertically downwards you cross the line that represents 1" 1/4 (the chosen diameter for the piping);
- from this point, move horizontally to the left until you meet the line that represents the length of 15 m of the piping;
- move vertically downwards to determine a value of 1.4 mbar in the pressure drop bottom scale;
- subtract the determined pressure drop from the meter pressure, the correct pressure level will be found for the choice of gas train;
- correct pressure = (20-1.4) = 18.6 mbar

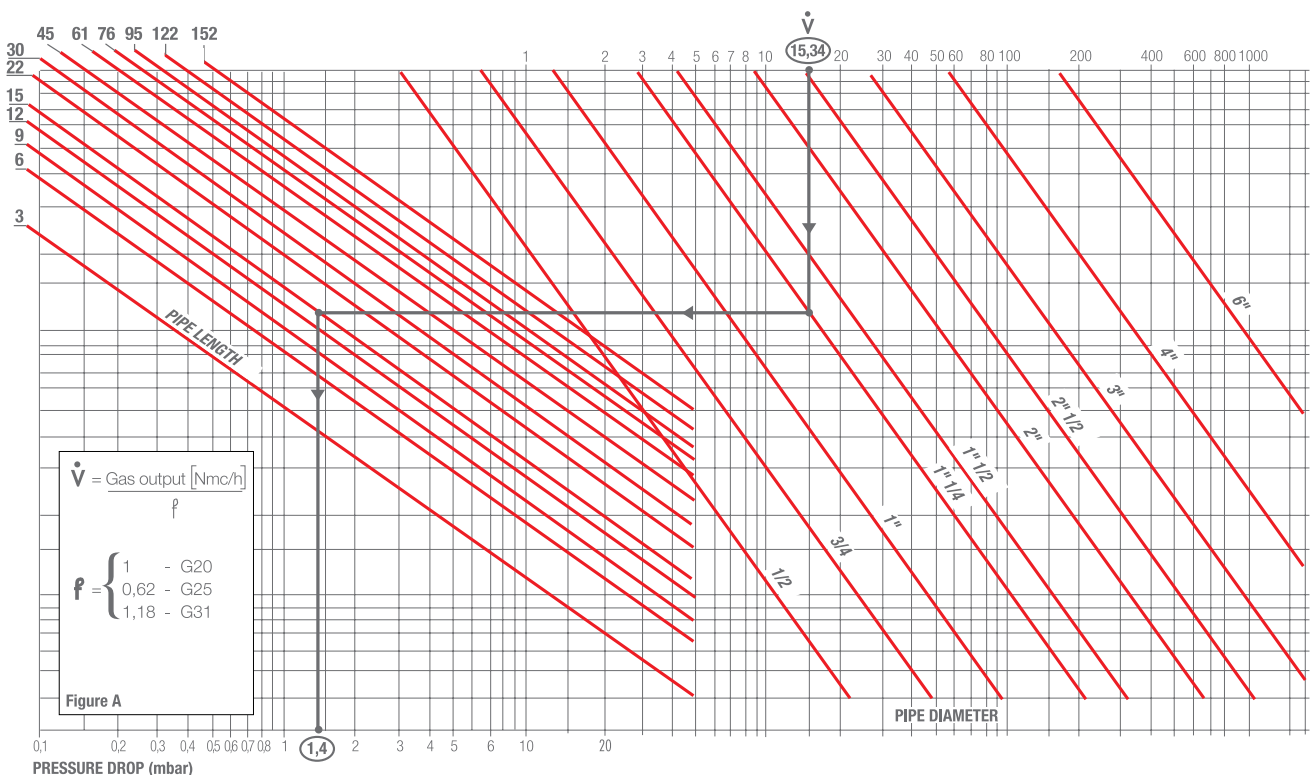

Ventilation

The ventilation circuit produces low noise levels with high performance pressure and air output, in despite of the compact dimensions.

On RS 45 - 68 - 120/E - /EV BLU models, the use of reverse curve blades and sound-proofing material keeps noise level very low. In the RS 25 - 35 - 160 - 200/E - /EV BLU models, noise has been reduced by the special design of the air suction circuit.

A stepper motor with high accuracy position and absence of joint clearance and mechanical hysteresis controls the air regulations, ensuring high fuel efficiency at all firing ranges.

A minimum air pressure switch stops the burner when there is an insufficient quantity of air at the combustion head.

The RS 25/E BLU and RS 35/E BLU are realised with a new structure made by an innovative technology based on a new fibreglass reinforced polyamide material, with high thermal and mechanical characteristics, instead of the traditional aluminium.

This allows big advantages in terms of lay-out rationalisation, weight and dimensions reduction.

In order to guarantee the correct exercise temperature for the internal burner components in every working conditions, the new structure includes an innovative patented cooling technology.

Between the burner front base and the reinforcing steel front plate, had been create an air cavity offering an high thermal insulation against the front boiler reflection heat, and to further improve the insulation efficiency the innovative **HCS (Housing Cooling System)** technology had been developed. Inside the front base cavity an air circulation is activated with continuous air volume refresh to obtain an active cooling system and avoid any heat transfer to the electrical component housing.



Example of stepper motor for air flow setting on RS 200/E - EV BLU burner.

Example of HCS (Housing Cooling System) working concept.

Combustion Head

Different lengths of the combustion head can be chosen for the RS/E - /EV BLU series of burners.

The choice depends on the thickness of the front panel and the type of boiler.

Depending on the type of generator, check that the penetration of the head into the combustion chamber is correct.

The internal positioning of the combustion head can easily be adjusted to the maximum defined output by adjusting a screw fixed to the flange.



Example of a RS 45/E BLU burner combustion head.



Example of a RS 160/E BLU burner combustion head.

SUGGESTED COMBUSTION CHAMBER DIMENSIONS

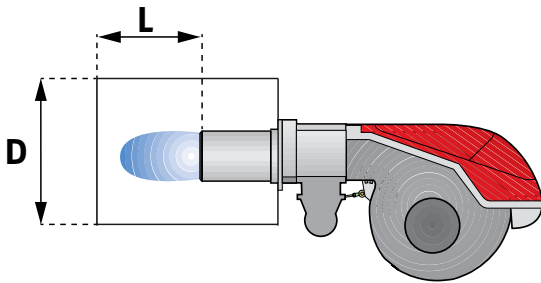

Example:
 Burner thermal output = 2000 kW;
 L Combustion Chamber (m) = 2,7 m (medium value);
 D Combustion Chamber (m) = 0,8 m (medium value)

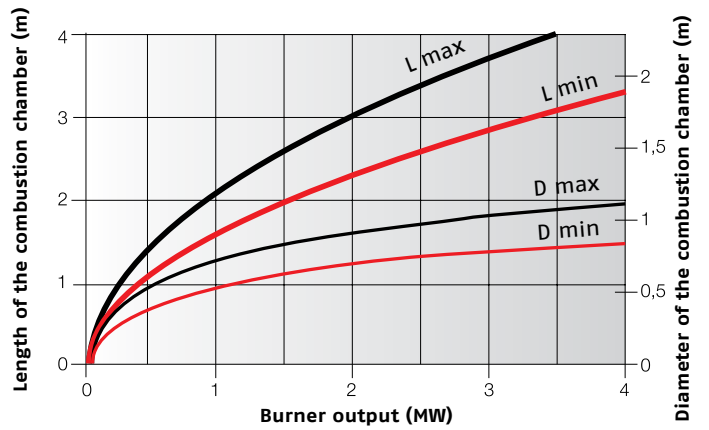

Operation

The models of RS/E - /EV BLU series of burners are based on the Digital Burner Management System, Riello REC27-REC37, which is able to manage the air-fuel ratio by independent servomotors in order to obtain a perfect output control and to assure a correct combustion and safe operation on all modulation range.

The new Combustion Management System includes the standard function of a Flame Control Panel and offers many advantages such as, for example, a simple and fast commissioning, the burner status and fault causes diagnostic to facilitate the maintenance, the Integrated Gas Valves Proving function.



Example of Riello REC27, Digital Burner Management System, installed on a RS 35/E BLU and RS 160/E BLU burner models.

The REC27-37 Electronic Cams, control the complete burner operating cycle, included the valves proofing test before the start-up, and the correct air-fuel mixing in every point of modulation range.

The actuators, connected to the air damper and fuel adjusting device with absence of joint clearance and mechanical hysteresis, are stepper motors with high accuracy position while the Display Interface RDI21 is the operating unit to easily adjust the system.

Operation can be "two stage progressive" or "modulating" with the installation of RWF40 electronic modulator and related temperature or pressure probe.

REC ELECTRONIC CAM SYSTEM

The REC37 version, used in the /EV models is suitable for continuous operation, variable speed drive operation and with 4/20 mA remote analogue control signal.

Function	Digital Burner Management System Model	
	REC27	REC37
Intermittent	●	●
Continuous operation		●
Two stage progressive operation	●	●
Modulating operation with the installation of a PID electronic regulator	●	●
Variable speed drive operation		●
Valve proofing system	●	●
Air fuel mixing control	●	●
Independent Ignition Point Position	●	●
Closed air damper during burner stand-by	●	●
Password protection levels	●	●
Burner status display	●	●
Error message	●	●
Error hystory	●	●
Remote lockout reset	●	●
Continuous Ventilation	●	●
Start without pre-purging	●	●
Remote Connections by external OCI410-412 modules	●	●
4/20 mA Remote Analogue Control signal		●
Indication of current burner output DC 0 ... 10 V	●	
Indication of current burner output DC 0 ... 10 V (alternative to VSD control)		●

FAN SPEED CONTROL (ON DEMAND)

The inverter device fitted to the RS/EV series burner acts on the electrical supply frequency of the fan motor to adjust the air flow through the motor speed variation.

The main advantages of speed control:

- lower sound emissions
- electric power saving.

The fan motor supplies just the necessary air flow, thus reducing sound emissions and avoiding energy loss due to the air damper regulation mechanism. The inverter technology can save up to 35% of the energy costs.

A safety device to verify the correct speed of the motor is mounted on the air suction circuit of the burner.

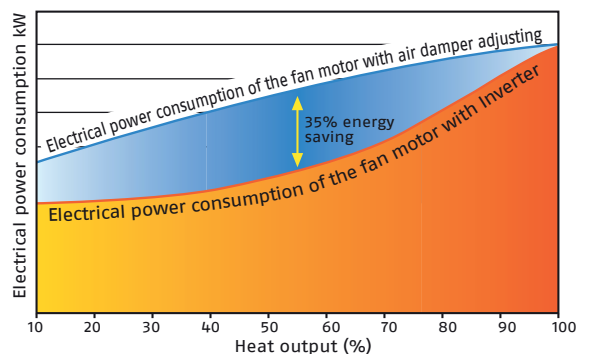

REC27-37 DIGITAL BURNER MANAGEMENT SYSTEM LAYOUT.

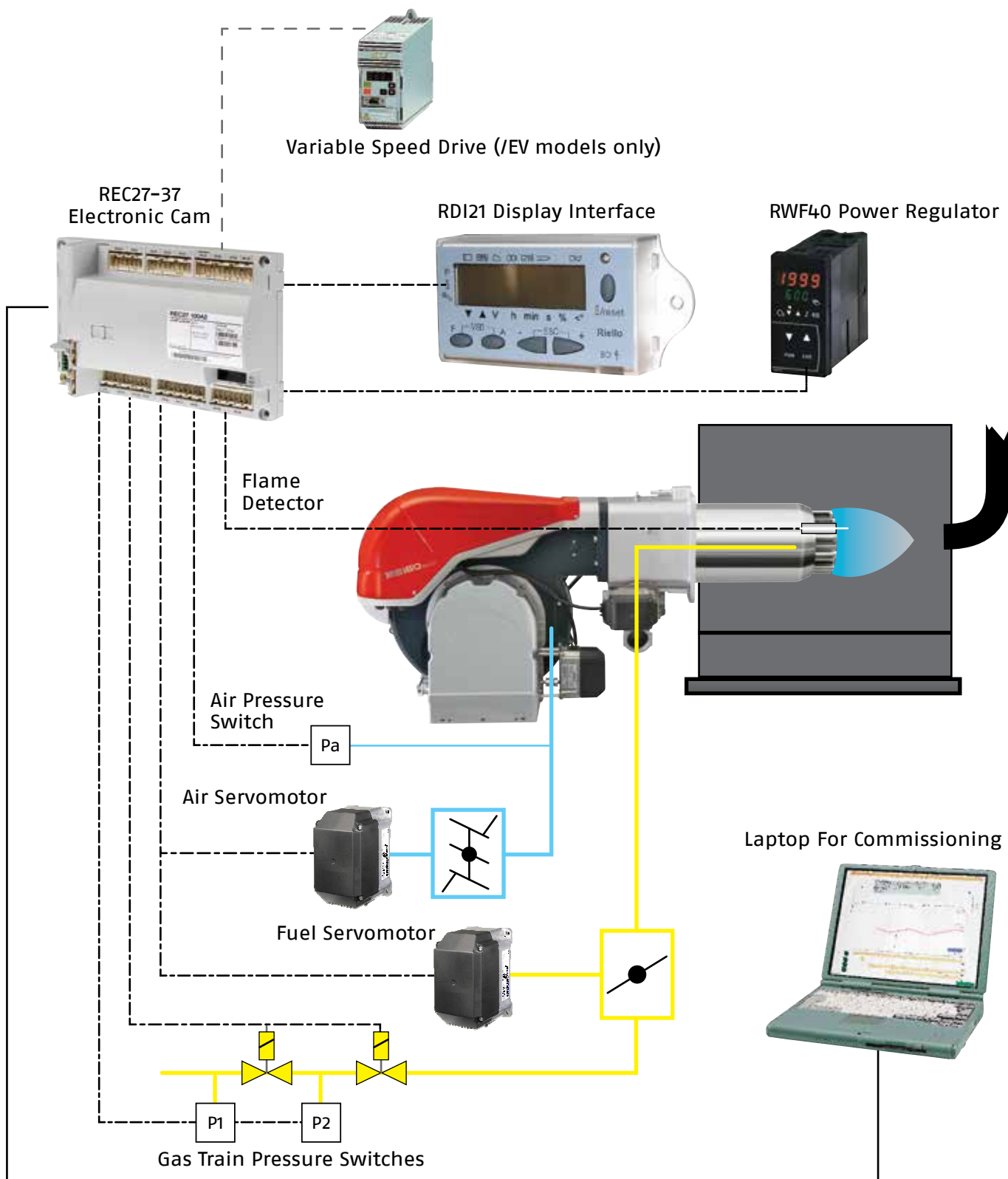

Remote Connections

It is possible to connect the REC27-37 electronic cam to a data network based on a Modbus system by using of its Modbus functionality.

This facilitates implementation of the following applications:

- Visualisation of plant states
- Plant control
- Logging

The physical connection to the Modbus system is made via an external OCI module.

The transmission mode used is RTU (Remote Terminal Unit).

The data are transmitted in binary format (hexadecimal) with 8 Bits.

The LSB (least significant bit) is transmitted first.

ASCII mode is not supported.

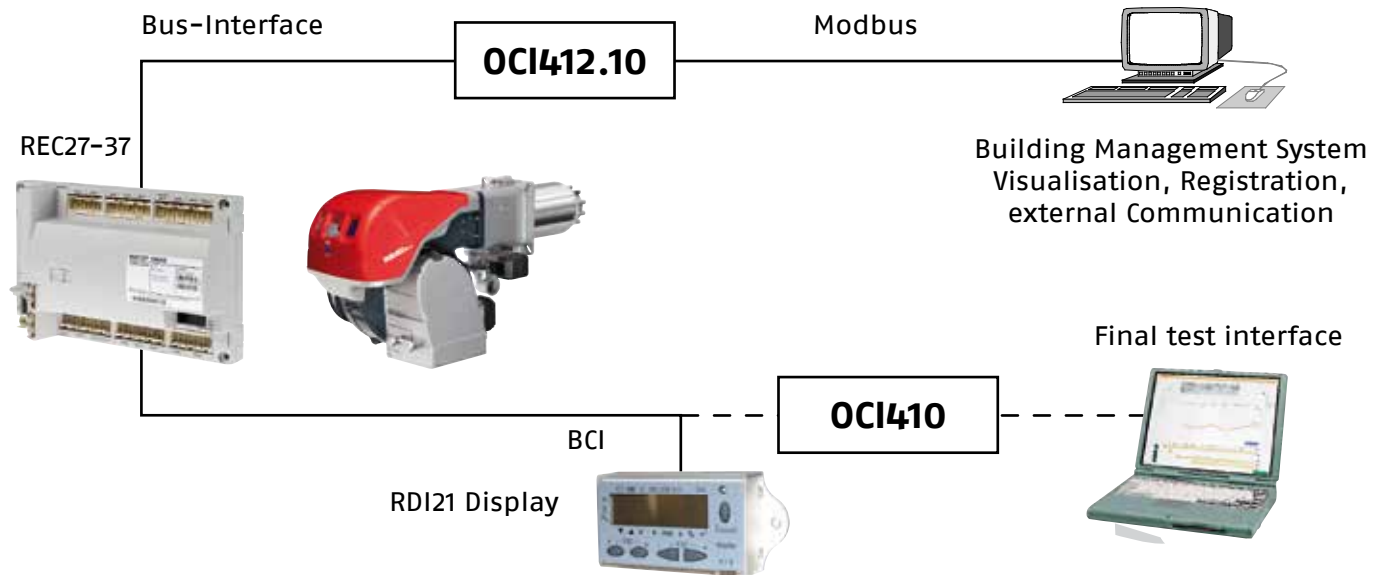

REC27 Remote Connections layout.

Emissions

The emissions have been measured in various models at maximum output, according to EN 676 standard.

NO2 EMISSIONS (gas G20)

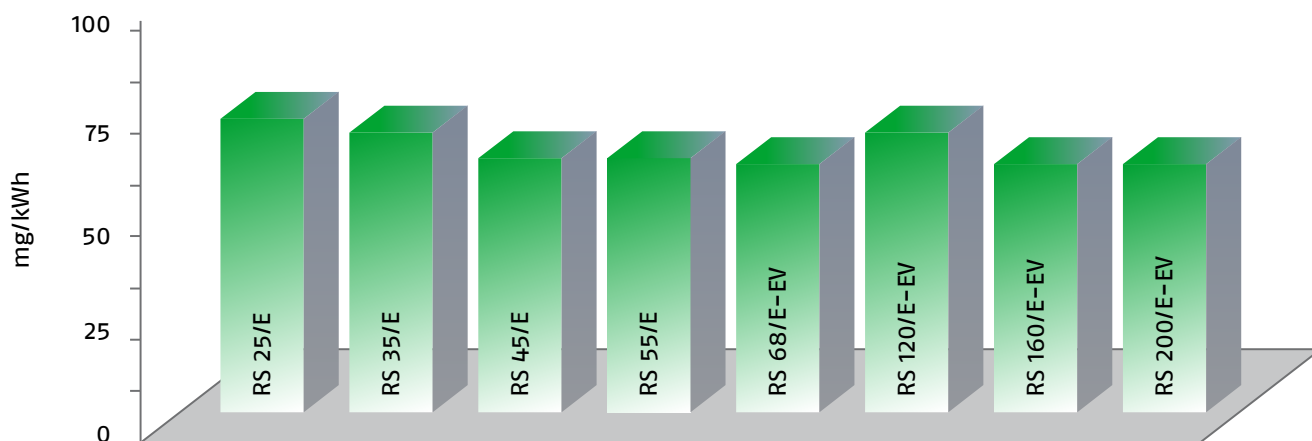

CO EMISSIONS (gas G20)

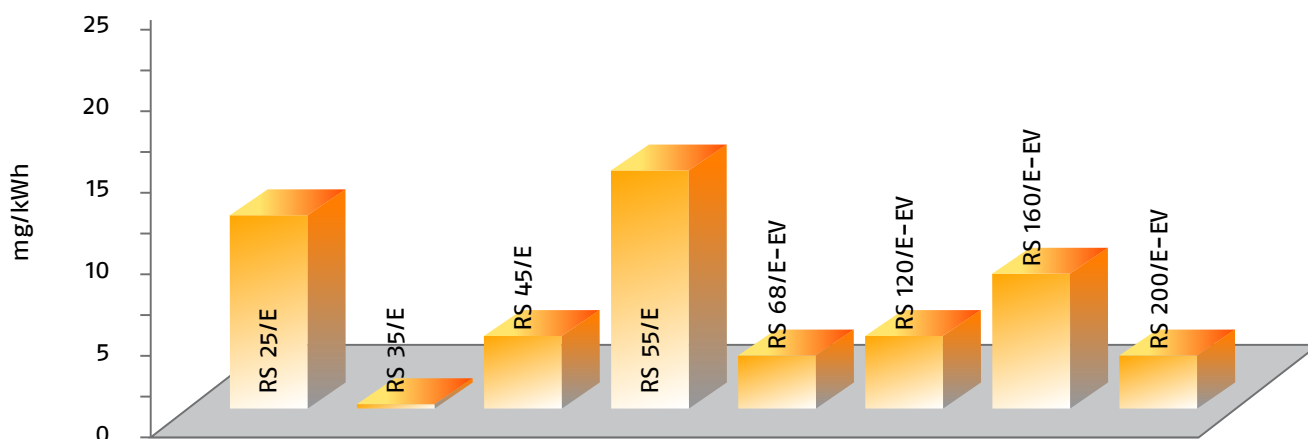

NOISE EMISSIONS

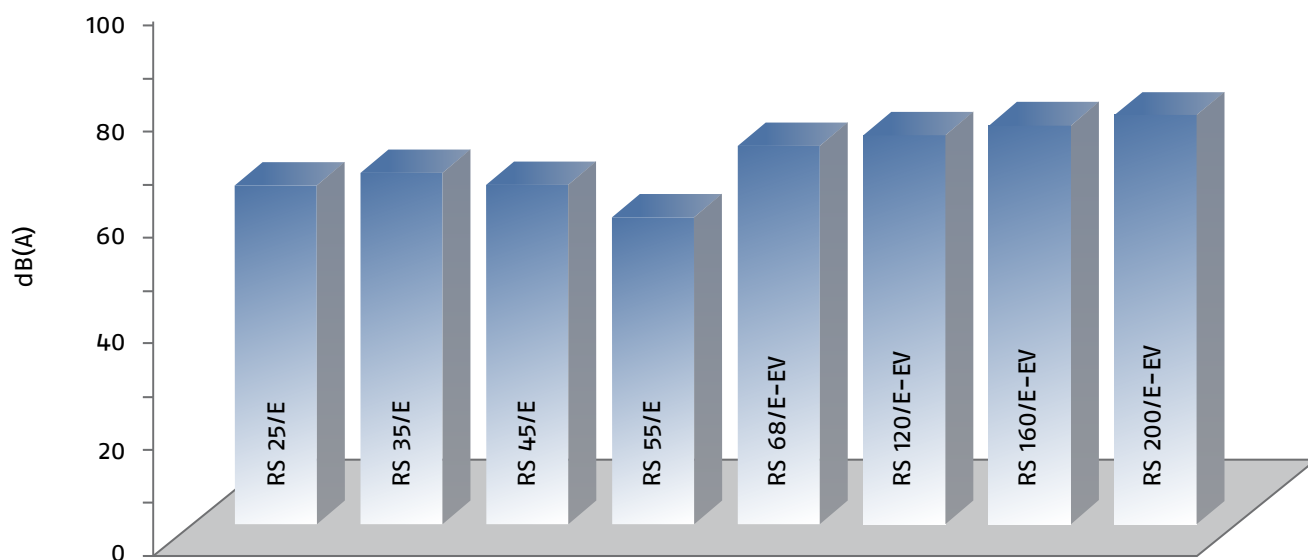

The noise emissions have been measured at the maximum output.

The RS/E -/EV BLU series combustion heads reduce polluting emissions thanks to their special design which optimises the air fuel mix.

The RS 25/E - 35/E - 45/E BLU models have an oblique radial pipe distributor through which gas is injected directly into the passing air flow for a perfect distribution.

This prevents no homogeneous concentrations in the flame with areas of high oxidation; part of the premixed gas/air is injected into the centre of the flame.

These methods produce a very stable flame with gradual and progressive combustion as the flame develops, thus giving polluting emission values below even the most restrictive norm values.

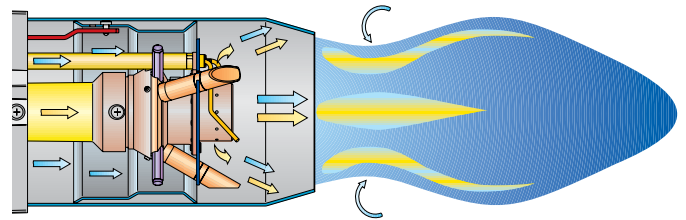

Combustion head operating diagram of RS 25/E - 35/E BLU models.

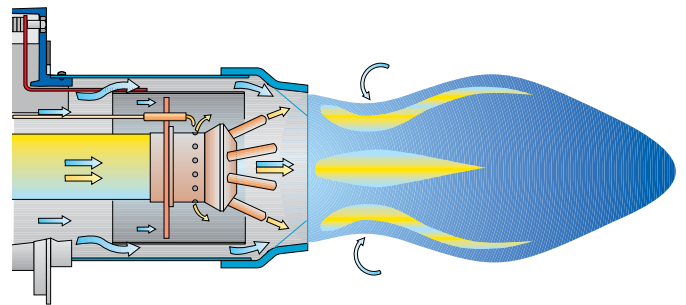

Combustion head operating diagram of RS 45/E BLU model.

In RS 68/E-/EV - 120/E-/EV - 160/E-/EV - 200/E-/EV BLU models part of the gas is distributed through outlets which are perpendicular to the air flow, while the remaining gas is injected directly into the centre of the flame.

This prevents no homogeneous concentrations in the flame with areas of high oxidation, producing very stable flame with gradual and progressive combustion as the flame develops, thus giving polluting emission values below even the most restrictive norm values.

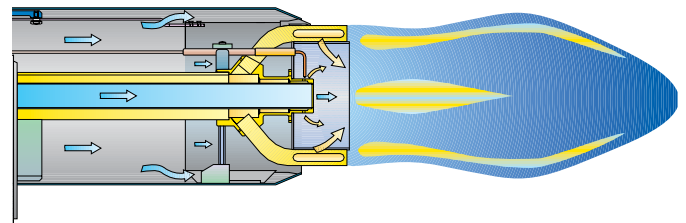

Combustion head operating diagram of RS 68/E-/EV - 120/E-/EV RS 160/E-/EV - 200/E-/EV BLU models.

Overall dimensions (mm)

BURNER

RS 25/E - 35/E BLU

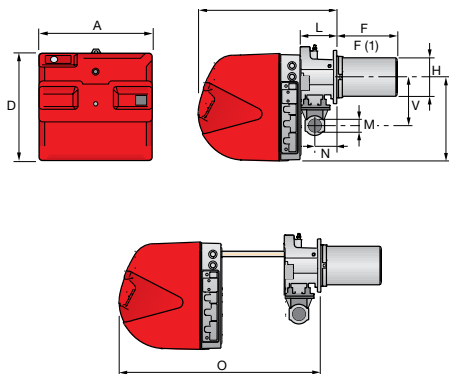

RS 45/E - 55/E BLU

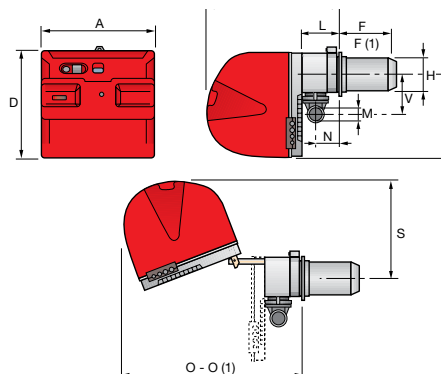

RS 68/E-EV - 120/E-EV - 160/E-EV - 200/E-EV BLU

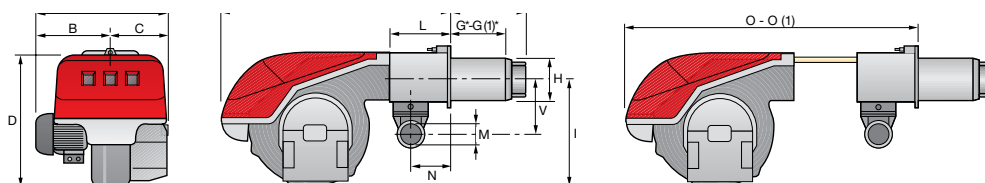

MODEL	A	B	C	D	E	F	F ⁽¹⁾	G*	G ^{(1)*}	H	I	L	M	N	O	O ⁽¹⁾	S	V
RS 25/E BLU	442	-	-	422	508	230	365	-	-	140	305	138	1 ^{11/2} "	84	780	-	-	177
RS 35/E BLU	442	-	-	422	508	230	365	-	-	152	305	138	1 ^{11/2} "	84	780	-	-	177
RS 45/E BLU	476	-	-	474	580	229	354	-	-	160	352	164	1 ^{11/2} "	108	810	810	367	168
RS 55/E BLU	533	300	-	490	640	255	390	-	-	189	352	222	2"	134	870	-	-	221
RS 68/E-EV BLU	527	312	215	555	840	255	390	200	335	189	430	214	2"	134	1161	1296	-	221
RS 120/E-EV BLU	553	338	215	555	840	255	390	200	335	189	430	214	2"	134	1161	1296	-	221
RS 160/E-EV BLU	671	366	305	555	863	373	503	272	402	221	436	221	2"	141	1442	1587	-	264
RS 200/E-EV BLU	737	432	305	555	863	373	503	272	402	221	436	221	2"	141	1442	1587	-	264

(1) dimension with extended head.

* Maximum depth of the boiler door including the depth of the burner flange insulating gasket.

BURNER – BOILER MOUNTING FLANGE

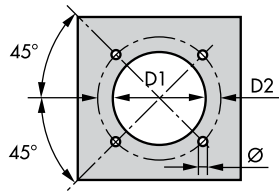

MODEL	D1	D2	Ø
RS 25/E BLU	160	224	M8
RS 35/E BLU	160	224	M8
RS 45/E BLU	165	224	M8
RS 55/E BLU	185	275-325	M12
RS 68/E-EV BLU	195	275-325	M12
RS 120/E-EV BLU	195	275-325	M12
RS 160/E-EV BLU	230	325-368	M16
RS 200/E-EV BLU	230	325-368	M16

PACKAGING

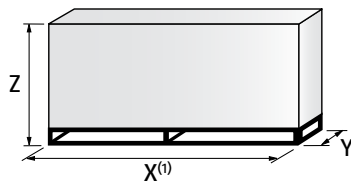

MODEL	X ⁽¹⁾	Y	Z	kg
RS 25/E BLU	1000	485	500	39
RS 35/E BLU	1000	485	500	40
RS 45/E BLU	1015	500	630	48
RS 55/E BLU	1405	700	660	44
RS 68/E-EV BLU	1405	700	660	78
RS 120/E-EV BLU	1405	700	660	84
RS 160/E-EV BLU	1405-1420	1000	660	89
RS 200/E-EV BLU	1405-1420	1000	660	125

(1) dimension with standard and extended head

Installation Description

Installation, start up and maintenance must be carried out by qualified and skilled personnel. All operations must be performed in accordance with the technical handbook supplied with the burner.

BURNER SETTING

All the burners have slide bars, for easier installation and maintenance.

After drilling the boilerplate, using the supplied gasket as a template, dismantle the blast tube from the burner and fix it to the boiler.

Adjust the combustion head.

Fit the gas train, choosing this on the basis of the maximum output of the boiler and considering the enclosed diagrams.

Refit the burner casing to the slide bars.

Close the burner, sliding it up to the flange.

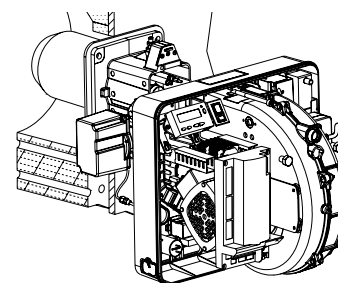
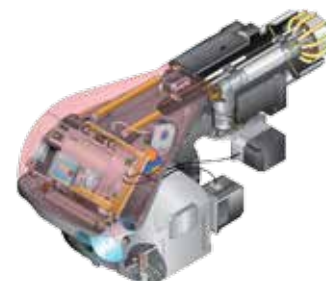

ELECTRICAL CONNECTIONS AND START UP

Make the electrical connections to the boiler following the wiring diagrams included in the instruction handbook.

Turn the motor to check rotation direction (if it is a three-phase motor).

Perform a first ignition calibration on the gas train.

On start up, check:

- Gas pressure at the combustion head (to max. and min. output)
- Combustion quality, in terms of unburned substances and excess air.

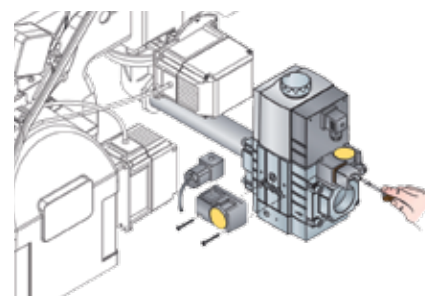

BURNER MAINTENANCE

The maintenance of RS/E-/EV BLU burners is very simple thanks to the sliding bars system that allows an easy access to the internal components.

In particular the RS 25-35/E BLU models have a new sliding bars system to make easier the access to the combustion head.

The RS 160-200/E-/EV BLU have new reinforced sliding bars that make very strong the burner structure during maintenance.

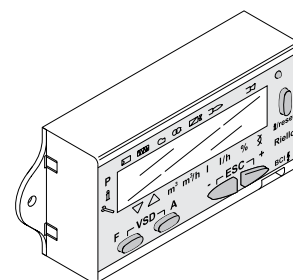
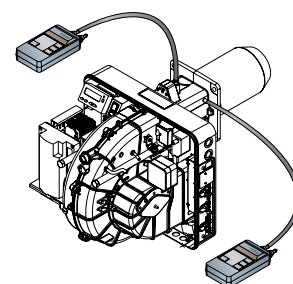

Burner Accessories

Extended head kit

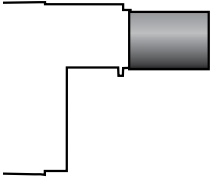

“Standard head” burners can be transformed into “extended head” versions, by using the special kit. The KITS available for the various burners, giving the original and the extended lengths, are listed below.

BURNER	STANDARD HEAD LENGTH (mm)	EXTENDED HEAD LENGTH (mm)	KIT CODE
RS 25/E BLU	230	365	3010430
RS 35/E BLU	230	365	3010431
RS 45/E BLU	229	354	20006586
RS 55/E BLU	255	390	20040373
RS 68/E-EV - 120/E-EV BLU	255	390	3010177
RS 160/E-EV BLU	373	503	3010442
RS 200/E-EV BLU	373	503	3010474

Spacer kit



If burner head penetration into the combustion chamber needs reducing, varying thickness spacers are available, as given in the following list.

BURNER	SPACER THICKNESS S (mm)	KIT CODE
RS 25/E - 35/E - 45/E BLU	110	3010095
RS 55/E - 68/E-EV - 120/E-EV BLU	135	3010129
RS 160/E-EV - 200/E-EV BLU	102	3000722

Continuous ventilation kit



If the burner requires continuous ventilation in the stages without flame, a special kit is available as given in the following table.

BURNER	KIT CODE
RS 25/E - 35/E BLU	3010449
RS 45/E - 55/E - 68/E-EV - 120/E-EV - 160/E-EV - 200/E-EV BLU	3010094

Note: the Post-ventilation function is obtainable by modification of the Digital Burner Management System parameters (see burner instruction manual).

Sound proofing box

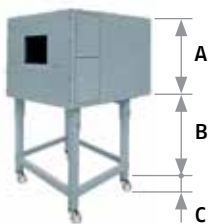

If noise emission needs reducing even further, sound-proofing boxes are available.

In case of generator heights, where a lower dimension “B” is required, ask for the Box Support Kit code 20065135.

BURNER	BOX TYPE	A (mm)	B (mm) min-max	C (mm)	[dB(A)] (*)	BOX CODE
RS 25/E - 35/E - 45/E - 55/E BLU	C1/3	650	372 - 980	110	10	3010403
RS 68/E-EV - 120/E-EV - 160/E-EV - 200/E-EV BLU	C4/5	850	160 - 980	110	10	3010404

(*) Average noise reduction according to EN 15036-1 standard

Accessories for modulating operation



To obtain modulating operation, the RS/E BLU series of burners requires a regulator with three point outlet controls. On RS 25/E - 35/E BLU the regulator is connected to the burner electrical wiring by plug-in system in order to make the connection easier and faster.

The following table lists the accessories for modulating operation with their application range.

BURNER	REGULATOR TYPE	REGULATOR CODE
RS 25/E - 35/E - 45/E - 55/E BLU	RWF 40	3010417
RS 68/E-EV - 120/E-EV - 160/E-EV - 200/E-EV BLU	RWF 40	3010414



The relative temperature or pressure probes fitted to the regulator, must be chosen on the basis of the application.

BURNER	PROBE TYPE	RANGE (°C) (bar)	PROBE CODE
All models	Temperature PT 100	-100 ÷ 500°C	3010110
	Pressure 4 ÷ 20 mA	0 ÷ 2,5 bar	3010213
	Pressure 4 ÷ 20 mA	0 ÷ 16 bar	3010214
	Pressure 4 ÷ 20 mA	0 ÷ 25 bar	3090873

Head kit for "reverse flame chamber"



In certain cases, the use of the burner on reverse flame boilers can be improved by using an additional Pipes Kit.

BURNER	KIT CODE
RS 68/E-EV BLU	3010247
RS 120/E-EV BLU	3010248
RS 160/E-EV BLU	3010249
RS 200/E-EV BLU	20035848

Ground fault interrupter kit



A "Ground fault interrupter kit" is available as a safety device in case of electrical system fault.

BURNER	KIT CODE
RS 25/E - 35/E BLU	3010448
RS 55/E BLU	3010321

Gas max pressure switch

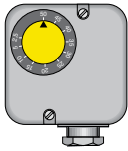

If necessary a Gas max pressure Switch kit is available and connectable to the burner electrical wiring trough Plugs & Sockets system.

BURNER	CODE
RS 25/E - 35/E BLU	3010418

Volt free contact kit



A volt free contact kit is available for installation onto the burner. It can be used for a remote interface between burner operating signals. Every burner can be equipped with a single kit for a remote check of the flame presence signal and the burner lockout indication.

BURNER	KIT CODE
RS 25/E - 35/E BLU	3010419

LPG kit

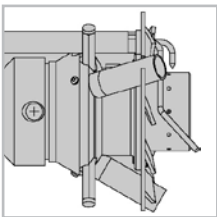

For burning LPG gas, a special kit is available to be fitted to the combustion head on the burner, as given in the following table:

BURNER	KIT CODE FOR 'STANDARD HEAD'	KIT CODE FOR 'EXTENDED HEAD'
RS 25/E BLU	3010423	3010423
RS 35/E BLU	3010424	3010424
RS 45-55-68-120-160-200/E BLU	in progress	in progress
RS 200/E-EV BLU	3010491	3010491

OCI410 interface for ACS410 software kit



Interface kit between burner management system and PC. It facilitates viewing, handling and recording setting parameters on site.

BURNER	KIT CODE
All models	3010436

OCI412 interface kit



Interface kit between the REC27.100A2 and a Modbus system, such as a building automation and control system (BACS). The Modbus interface is based on the RS-485 standard.

BURNER	KIT CODE
All models	3010437

DN80 gas flange kit

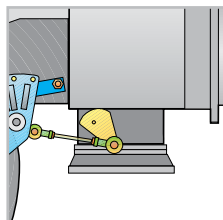

To modify the standard 2" burner gas input connection in to DN80 connection, a specific gas flange is available.

BURNER	KIT CODE
RS 68/E-EV - 120/E-EV - 160/E-EV - 200/E-EV BLU	3010439

Variable Speed Drive (VSD) for RS/EV series only











The motor speed variation for the RS/EV BLU burners series is obtained thanks to a frequency converter: variable speed drive (VSD).

BURNER	MAX POWER (kW)	KIT CODE
RS 68/EV BLU	1,5	20063532
RS 120/EV BLU	3,0	20063533
RS 160/EV - 200/EV BLU	5,5	20062679

Gas train accessories

Adapters

When the diameter of the gas train is different from the set diameter of the burners, an adapter must be fitted between the gas train and the burner. Below are given the available adapters; please see on the Gas Train list the correct adapter codes to select.

ADAPTER	LENGTH mm	ADAPTER CODE
2"  1" 1/2	70	3000822
3/4"  1" 1/2	31	3000824
DN 65  2" 1/2  1" 1/2	300	3000825
DN 80  2" 1/2  2"	300	3000826
1" 1/2  2"	35	3000843
1" 1/4  1" 1/2	35	3010124
1" 1/4  2"	35	3010126

PVP (Pressure Valve Proving) kit *

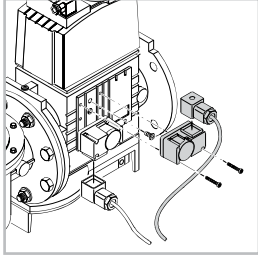

The seal control function is included on Burner Digital Management System, it is only necessary to add the PVP kit on the gas train. The PVP is included as standard equipment on RS 120/E-EV-160/E-EV-200/E-EV BLU models.

GAS TRAIN	KIT CODE
MB - MBC - CB - DMV type	3010344

* not necessary for the RS 120/E-EV - 160/E-EV - 200/E-EV BLU models where is included as a standard.

Stabiliser spring



Accessory springs are available to vary the pressure range of the gas train composed. The following table shows these accessories with their application range. Please refer to the technical manual for the correct choice of spring.

Gas train	SPRING Colour	SPRING Pressure range (mbar)	SPRING Code
MBC 1900/1* - 3100/1* 5000/1*	White	4 - 20	3010381
	Red	20 - 40	3010382
	Black	40 - 80	3010383
	Green	80 - 150	3010384
CB 512/1* - DMV 512/1*	Red	25 - 55	3010131
	Black	60 - 110	3010157
	Pink	90 - 150	3090486
CB 520/1* - 525/1* DMV 520/1 - 525/1*	Red	25 - 55	3010132
	Black	60 - 110	3010158
	Pink	90 - 150	3090487
CB 5065/1* - 5080/1* DMV 5065/1* - 5080/1*	Red	25 - 55	3010133
	Black	60 - 110	3010135
	Pink	100 - 150	3090456
	Grey	140 - 200	3090992
CB / DMV 50100/1*	Red	25 - 55	3010134
	Black	60 - 110	3010136
	Pink	100 - 150	3090489
	Grey	140 - 200	3092174
CB / DMV 50125/1*	Red	25 - 55	3010315
	Yellow	30 - 70	3010316
	Black	60 - 110	3010317
	Pink	100 - 150	3010318

Specification

Designation of series

A specific index guides your choice of burner from the various models available in the RS/E - /EV series. Below is a clear and detailed specification description of the product.

Series: R											
Fuel:		S	Natural Gas								
		L	Light oil								
		LS	Light oil/Natural Gas								
		N	Heavy oil								
Size											
Setting :		/1	Single stage				/E	Electronic cam			
		/B	Two stage				/P	Proportioning air/gas valve			
		/M	Modulating - Mechanical cam				/EV	Electronic cam predisposed for variable speed (with inverter)			
Emission :		C11 or ...	Class 1 EN267 - EN676								
		C22 or MZ	Class 2 EN267 - EN676								
		C33 or BLU	Class 3 EN267 - EN676								
		C23 or MX	Class 2 EN267 - Class 3 EN676								
		C13	Class 1 EN267 - Class 3 EN676								
Head length:		TC	standard head								
		TL	extended head								
Flame control system:											
		FS1	Standard (1 stop every 24 h)								
		FS2	Continuous working (1 stop every 72 h)								
Electrical supply to the system:											
		1/230/50	1/230V/50Hz								
		3/230/50	3/230V/50Hz								
		3/400/50	3N/400V/50Hz								
		3/230-400/50	3/230V/50Hz - 3N/400V/50Hz								
		3/220/60	3/220V/60Hz								
		3/380/60	3N/380V/60Hz								
		3/220-380/60	3/220/60Hz - 3N/380V/60Hz								
Auxiliary voltage:											
		230/50-60	230V/50-60Hz								
		110/50-60	110V/50-60Hz								
R	S	120	/E	BLU	TC	FS1	3/230-400/50	230/50-60			
BASIC DESIGNATION				EXTENDED DESIGNATION							

AVAILABLE BURNER MODELS

RS 25/E BLU	TC	FS1	1/220-230/50-60	220-230/50-60
RS 25/E BLU	TL	FS1	1/220-230/50-60	220-230/50-60
RS 35/E BLU	TC	FS1	1/220-230/50-60	220-230/50-60
RS 35/E BLU	TL	FS1	1/220-230/50-60	220-230/50-60
RS 35/E BLU	TC	FS1	3/220-400/50-60	220-230/50-60
RS 35/E BLU	TL	FS1	3/220-400/50-60	220-230/50-60
RS 45/E BLU	TC	FS1	1/230/50	230/50-60
RS 45/E BLU	TL	FS1	1/230/50	230/50-60
RS 55/E BLU	TC	FS1	3/230-400/50	230/50-60
RS 55/E BLU	TL	FS1	3/230-400/50	230/50-60
RS 68/E BLU	TC	FS1	3/230-400/50	230/50-60
RS 68/E BLU	TL	FS1	3/230-400/50	230/50-60
RS 120/E BLU	TC	FS1	3/230-400/50	230/50-60
RS 120/E BLU	TL	FS1	3/230-400/50	230/50-60
RS 160/E BLU	TC	FS1	3/400/50	230/50-60
RS 160/E BLU	TL	FS1	3/400/50	230/50-60
RS 200/E BLU	TC	FS1	3/400/50	230/50-60
RS 200/E BLU	TL	FS1	3/400/50	230/50-60
RS 200/E BLU	TC	FS1	3/230/50	230/50-60
RS 200/E BLU	TL	FS1	3/230/50	230/50-60
RS 68/EV BLU	TC	FS1/FS2	3/230-400/50	230/50-60
RS 68/EV BLU	TL	FS1/FS2	3/230-400/50	230/50-60
RS 120/EV BLU	TC	FS1/FS2	3/230-400/50	230/50-60
RS 120/EV BLU	TL	FS1/FS2	3/230-400/50	230/50-60
RS 120/EV BLU	TC	FS1/FS2	3/230-400/50	230/50-60
RS 160/EV BLU	TC	FS1/FS2	3/400/50	230/50-60
RS 160/EV BLU	TL	FS1/FS2	3/400/50	230/50-60
RS 160/EV BLU	TC	FS1/FS2	3/400/50	230/50-60
RS 200/EV BLU	TC	FS1/FS2	3/400/50	230/50-60
RS 200/EV BLU	TL	FS1/FS2	3/400/50	230/50-60
RS 200/EV BLU	TC	FS1/FS2	3/400/50	230/50-60

Other versions are available on request.

Product specification

STATE OF SUPPLY

RS 25/E - 35/E BLU models

Monoblock forced draught Low NO_x gas burner with two stage progressive or modulating operation, with a specific kit, fully automatic, made up of:

- Microprocessor-based Digital Burner Management System
- Display Interface operating unit to adjust the system
- Air suction circuit **with sound proofing material**
- High performance fan with straight blades
- Air damper for air flow setting and butterfly valve for regulating fuel output controlled by independent stepper motor actuators
- Starting motor at 2800 rpm, single-phase/220-230V/50-60Hz or three-phase/380-400V/50-60Hz
- low emission combustion head, that can be set on the basis of required output, fitted with:
 - stainless steel end cone, resistant to corrosion and high temperatures
 - ignition electrodes
 - ionisation probe
 - gas distributor
 - flame stability disk
- Exclusive patented HCS (Housing Cooling System) with high thermal insulation and air circulation with continuous air volume refresh for an active cooling system and avoid heat transfer to the electrical component housing
- Minimum air pressure switch stops the burner in case of insufficient air quantity at the combustion head
- Plugs and sockets for electrical connection, accessible from the external of the cover
- Burner on/off selection switch
- Flame inspection window
- Slide bars for easier installation and maintenance
- Protection filter against radio interference
- IP X0D (IP 40) electric protection level.

Standard equipment:

- 1 gas train flange
- 1 flange gasket
- 4 screws for fixing the flange
- 1 thermal screen
- 4 screws for fixing the burner flange to the boiler
- 3 plugs for electrical connection (RS 25-35/E BLU single-phase)
- 4 plugs for electrical connection (RS 35/E BLU three-phase)
- Instruction handbook for installation, use and maintenance
- Spare parts catalogue.

STATE OF SUPPLY

RS 45/E - 55/E - 68/E-EV - 120/E-EV - 160/E-EV - 200/E-EV BLU models

Monoblock forced draught Low NOx gas burner with two stage progressive or modulating operation, with a specific kit, fully automatic, made up of:

- Microprocessor-based Digital Burner Management System (RS/E BLU models)
- Microprocessor-based Digital Burner Management System with Variable Speed Drive technology for the control of a Frequency Inverter (RS/EV BLU models)
- Display Interface operating unit to adjust the system
- Air suction circuit lined with sound-proofing material
- Fan with reverse curve blades (straight blades on the 160/E-EV - 200/E-EV BLU model) high performance with low sound emissions
- Air damper for air flow setting and butterfly valve for regulating fuel output controlled by independent stepper motor actuators
- Starting motor at 2800 rpm, three-phase 400V with neutral, 50Hz (single-phase, 230V and 50Hz for the 45/E BLU model)
- Low emission combustion head, that can be set on the basis of required output, fitted with:
 - stainless steel end cone, resistant to corrosion and high temperatures
 - ignition electrodes
 - ionisation probe
 - gas distributor
 - flame stability disk
- Maximum gas pressure switch to stop the burner in the case of excess pressure on the fuel supply line (on RS 55-68-120-160-200/E-EV BLU models)
- Minimum air pressure switch stops the burner in case of insufficient air quantity at the combustion head
- Burner on/off selection switch
- Flame inspection window
- Slide bars for easier installation and maintenance
- Protection filter against radio interference
- IP 44 electric protection level.

Standard equipment:

- 1 gas train flange
- 1 flange gasket
- 4 screws for fixing the flange
- 1 thermal screen
- 4 screws for fixing the burner flange to the boiler
- Wiring loom fittings for the electrical connection (for RS 45/E BLU model)
- 2 slide bar extensions (for extended head models and RS 160/E-EV - 200/E-EV BLU)
- Pressure switch for valve proofing system (RS 68-120/E-EV BLU models)
- Instruction handbook for installation, use and maintenance
- Spare parts catalogue.

Riello Burners a world of experience in every burner we sell.



[1]



[2]

Across the world, Riello sets the standard in reliable and high efficiency burner technology.

With burner capacity from 5 kW to 48 MW, Riello gas, oil, dual fuel and Low Nox burners deliver unbeatable performance across the full range of residential and commercial heating applications, as well as in industrial processes.

With headquarter in Legnago, Italy, Riello has been manufacturing premium quality burners for over 90 year. The manufacturing plant is equipped with the most innovative systems of assembling lines and modern manufacturing cells for a quick and flexible response to the market.

Besides, the Riello Combustion Research Centre, located in Angiari, Italy, represents one of the most modern facility in Europe and one of the most advanced in the world for the development of the combustion technology.

Today, the company's presence on worldwide markets is distinguished by a well-constructed and efficient sales network, alongside many important Training Centres located in various countries to meet its customers' needs. Riello has 13 operational branches abroad (in Europe, America and Asia), with customers in over 60 countries.

[1] BURNERS PRODUCTION PLANT
S. PIETRO, LEGNAGO (VERONA) - ITALIA

[2] HEADQUARTER BURNERS DIVISION
S. PIETRO, LEGNAGO (VERONA) - ITALIA

RIELLO S.p.A. - 37045 Legnago (VR) - Italy
tel. +39 0442 630111 - fax: +39 0442 21980
www.riello.com

Since the Company is constantly engaged in the production improvement, the aesthetic and dimensional features, the technical data, the equipment and the accessories can be changed. This document contains confidential and proprietary information of RIELLO S.p.A. Unless authorised, this information shall not be divulged, nor duplicated in whole or in part.

RIELLO